

NEW

ISSUE 3

Part of the *Fabulous* pattern series

Fabulous

OCTOBER 2024

PATCHWORK APPLIQUÉ PATTERNS



WWW.FABULOUSPATTERNS.CO.UK

Christmas

Over 50 *Fabulous* patterns to make inside

NEW

ON SALE NOW

NEW

ISSUE 3

Part of the *Fabulous* pattern series

Fabulous

SEPTEMBER 2024

EMBROIDERY PATTERNS

WWW.FABULOUSPATTERNS.CO.UK

Fireside Favourites

Over **50** *Fabulous* patterns to make inside

THEMED PATTERNS – ALL SKILL LEVELS – EVERY MONTH

Part of the *Fabulous* pattern series

Christmas

patchwork appliqué

A warm welcome to the world of *Fabulous* Patterns. We are a team of pattern creators who love crafting and helping you make projects you will love. Each issue is themed, with all the patterns you will need in one place.

By the time we relax to craft from our busy lives, we find that we want something quick to work on, so we have aimed for each issue to have lots of ideas where you can simply choose what you need and get making. Our ideas for each issue are simple. There are over 50 templates for you to use in your creations, along with some fabulous ideas for what you can do with them and tips on how to use them.

In this Appliqué issue the focus is on all things Christmas. We are all animal lovers here and loved coming up with ideas that would be cute to stitch. Inside this issue you will find a host of different designs from cookies and candy canes to snowmen and Christmas stockings.

If you are a beginner we have provided some instructions for basic appliqué instructions to help get you started.

We hope the patterns provide you with lots of inspiration. If you have any ideas for future themes, do get in touch at info@fabulouspatterns.co.uk, we love to hear from you.

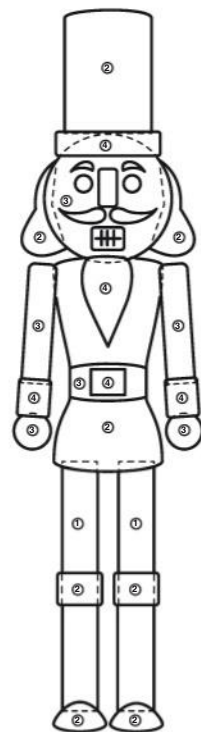

Happy Stitching
The Fabulous Patterns Team

Making
Fabulous
memories

Fabulous Patchwork Appliqué Patterns is part of the *Fabulous* Pattern Series www.fabulouspatterns.co.uk

Fabulous Patchwork Appliqué Patterns is registered at The British Library. ISSN:3049-558X (Online) **Issue 3, October 2024. All copyright jellymediaUK Ltd.**

No part of this publication may be reproduced in any format or sold by any means without prior written permission from the publishers. Every effort is made to ensure the accuracy of material published in *Fabulous* Patchwork Appliqué Patterns. However, jellymediaUK Ltd will not be liable for any inaccuracies. The views expressed by contributors are not necessarily those of the editor or publishers. Photos from Freepik and Unsplash.



Published by
jellymediaUK Ltd.

Appliqué

Easy Raw Edge Method

Appliqué is the name given to a textile technique where a piece of fabric is applied on top of another one. It can have functional uses, such as covering a tear and/or be decorative, for example sewing a heart shape onto a t-shirt.



There are many different ways of sewing appliqué, here is our favourite fast and easy method.

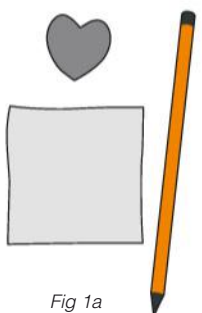

Fig 1a

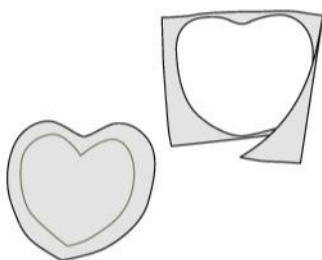

Fig 1b

Raw Edge

This is the simplest form of appliqué and is just one fabric applied on top of another. You can choose a fabric that does not fray, such as felt, and simply sew it in place and this can be a fun way to stitch with children. However, if you wish to do a more elaborate design you will likely want to use some sheets of fusible web. This is a heat activated glue and attaches the fabric motif to the background fabric. The finished result has a raw edge (is not hemmed) and so to make it more durable the edges will need securing with stitch.

- 1 Print your template and use a glue stick to attach it onto a piece of card (this can be some old packaging out of the recycling bin). Then cut out along the line using paper scissors. Take a piece of the paper backed fusible web. It has a rough side which is the glue which melts when ironed and the other is smooth and the paper backing. Place your template on the paper (smooth) side and draw around it. Cut out the shape, about a generous 1cm away from the pencil line. *Fig 1a and 1b*



2 Take your piece of fabric for the motif and place on an ironing board right side down. Put your fusible web shape on top paper (smooth) side up, then put the iron on top. Hold it in place for a few seconds till the web has stuck in place. *Fig 2*

3 Once the fabric is cool cut out the shape following the line. Peel the paper backing away. *Fig 3*

4 Place the fabric shape on your background fabric right side up. Put the iron on top and hold for a few seconds to activate the glue. This sticks the design to the backing fabric. *Fig 4*

5 Sew around the edge of the shape. As well as adding decoration it helps prevent fraying (the glue will likely come loose after time) so will make it more durable. *Fig 5*
Some suggestions for stitches around the edge are:

Hand sewing – running stitch, oversewing, crosses, blanket stitch.

Machine sewing - straight stitch, zig zag, decorative stitches. If machine sewing, you can put a piece of tear away stabiliser on the back to help prevent the fabric from distorting when you sew.

Tips

- Read the instructions that come with the fusible web as this will have handy information such as telling you what temperature to heat your iron and how long to hold the iron on top of the fabric to fuse it in place.
- If peeling off the paper backing is proving tricky (Step 3) try gently scoring the middle with a pin to loosen the paper.
- If the backing fabric looks like it will shadow through the motif (such as applying a light yellow fabric onto a black and white stripe) you can fuse two layers of fabric together to create an opaquer shape.
- Place a piece of baking paper on your ironing board and another on top of your fabric to protect your iron and board from any stray glue melting out the edges.

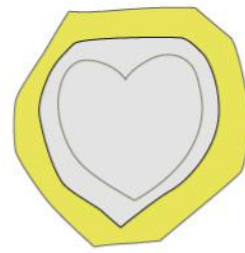

Fig 2

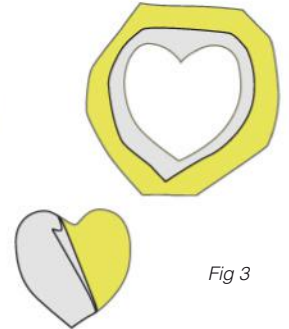

Fig 3

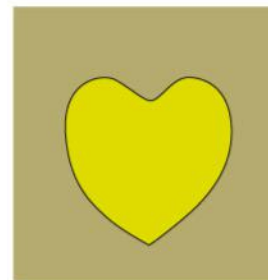

Fig 4

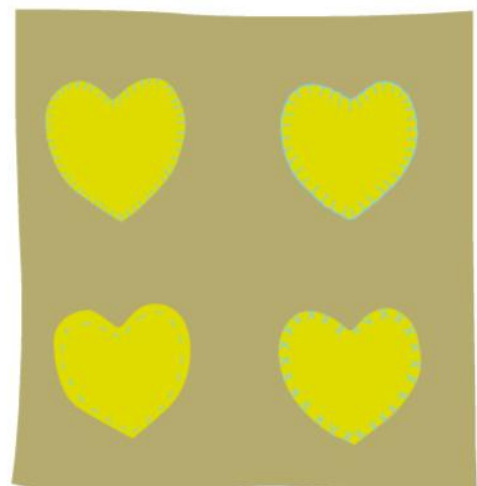

Fig 5

Appliqué

Templates and Layers



Using the Templates

You can either cut and layer your fabric by eye as you go or follow the instructions below. This method creates a layout template that lays on top of the fabric and you can place your pieces underneath it to check they are where you want them to be. It can be especially useful if you are making a complex design.

- 1 Print out the template and number the pieces by writing on each one.
- 2 Trace each piece onto tracing paper or baking paper, including the number of the piece. Lightly mark in any places the pieces are overlapped. You could also print off several copies of the original and cut your pieces straight from that instead of tracing.
- 3 Glue the templates to card and cut out.
- 4 Prepare your fabric pieces.
- 5 Go back to the original image and trace this onto tracing paper, lightweight sew-in interfacing or baking paper.
- 6 Take your backing fabric, then place the transparent template from Step 5 on top and pin on one edge to keep in place. You can now use this as a guide to where the pieces should go.
- 7 Take the first piece of the applique (that will be at the back) and lay it on the backing fabric. Lift up and replace the transparent template as needed to get the position right. When happy with the position fuse the fabric in place. Then repeat to complete the design.

Template Tip

When using the template you may need to reverse (mirror) the design. Always take time before tracing around the template to ensure the finished item will be facing the way you wish, this is especially important things that cannot be reversed such as lettering.

Fabric

The great thing about applique is all types of fabric can be used, however do consider how the item will be used and how the fabric will be washed. Also, the weight of the applique can affect the finished item, for example if working on a layered design you may want lighter fabrics but if appliquéing a motif over a hole in pair of jeans you may wish to use something that is also hard wearing.



Layers

The more layers of fused applique you have, the harder it can be to get your needle through. To help with this you can cut away the sections that will be overlapped. Another tip is to cut the inside of the fusible web before fusing to the back of the fabric.

To do this cut the shape, then cut away the inside, leaving about 1cm around the edge. This means only the edge of the fabric is fused and not the inside. There are also different types of fusible web available to buy and some are a lot thinner than others so experiment with a few different types.

When motifs are layered pause to consider the order in which you will work and what how fabrics are being overlapped.

It is possible to work very small areas of applique however you might find it easier to embroider these areas.



Project Ideas

Some ideas of finished items to show off your applique designs:

Clothing – take a plain t-shirt and add a design on the front, back or even the sleeve. Cover a hole in a pair of trousers or add some interest to a garment, for example adding applique to a pocket.

Tote bag – if you have some freebie tote bags in the cupboard then adding applique to them can give them a good update and is quick to do.

Oven gloves and tea-towels – rather than throwing them away when they have a scorch mark or stain, cover them with applique. You can also create some unique designs by giving shop bought items an applique update.

Table mats and coasters – these are small and fun to make and a quick way to display applique and make something unique for the home. They can easily be changed with the seasons.

Wash bags and glasses case – many people use these daily and so they are good items to add motifs to give a personalised touch.

Bunting – if you want to try out lots of different applique designs then displaying them as bunting is great as each flag can have a different design. The pennants do not have to be triangular, they can be semi-circles or square and a mixture of sizes.

Greetings Card – applique a design onto a piece of fabric and cut this slightly smaller than the piece of card and glue onto the backing (double sided sticky tape can be good for this).

Let's get ready for Christmas. Why not use our fabulous patterns, create some cute and fun festive decorations and bring a little magic to your home this season. With over 50 patterns to choose from you won't be short of ideas!

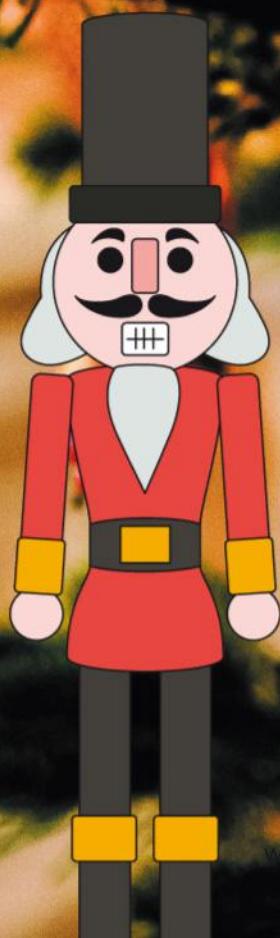



WISE MAN

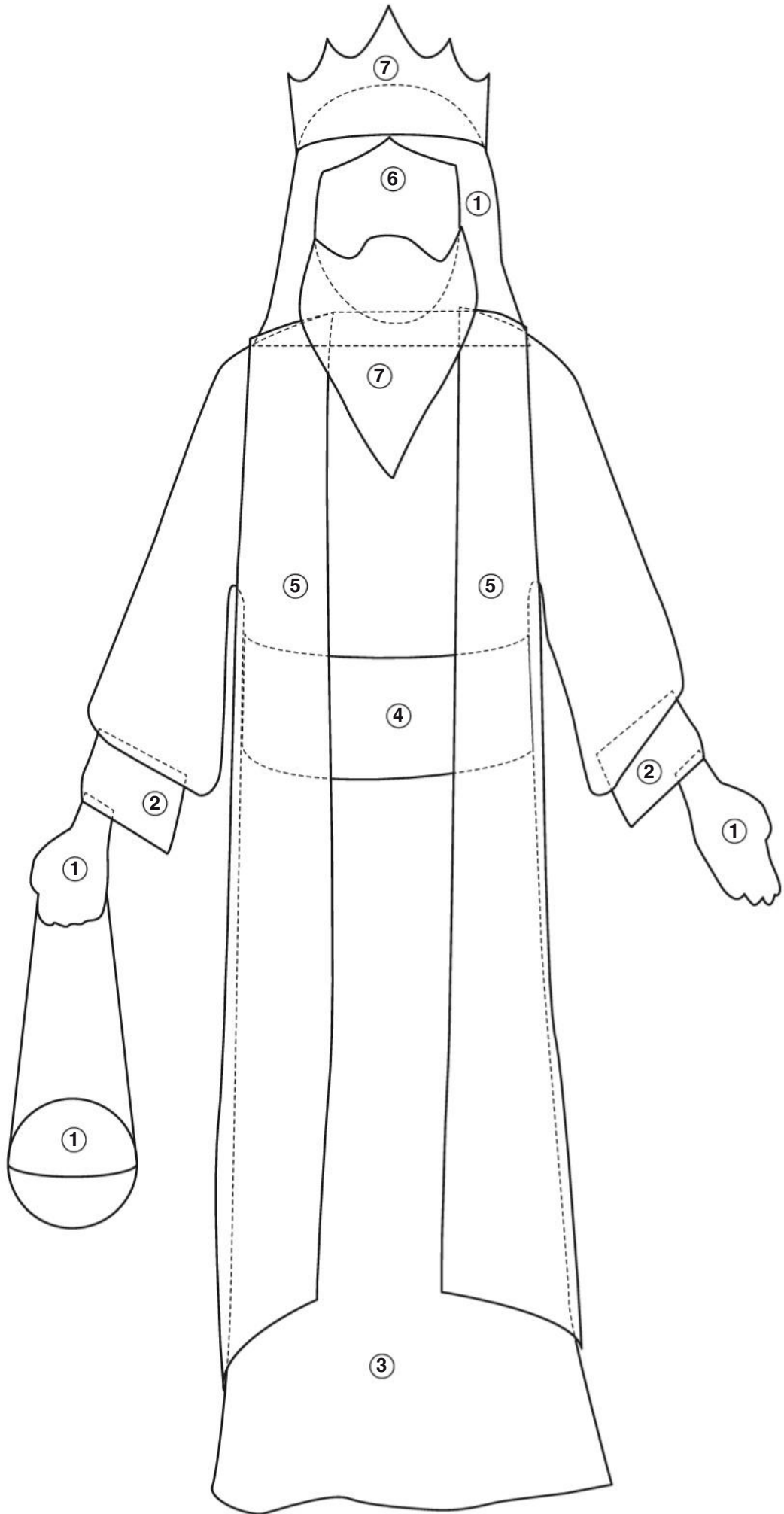

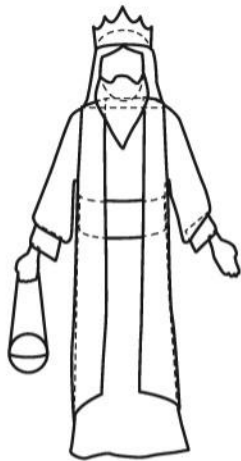
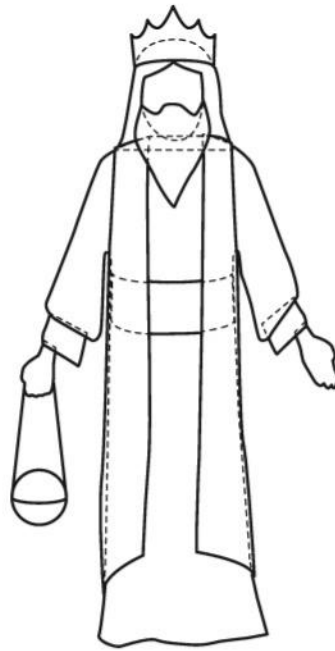
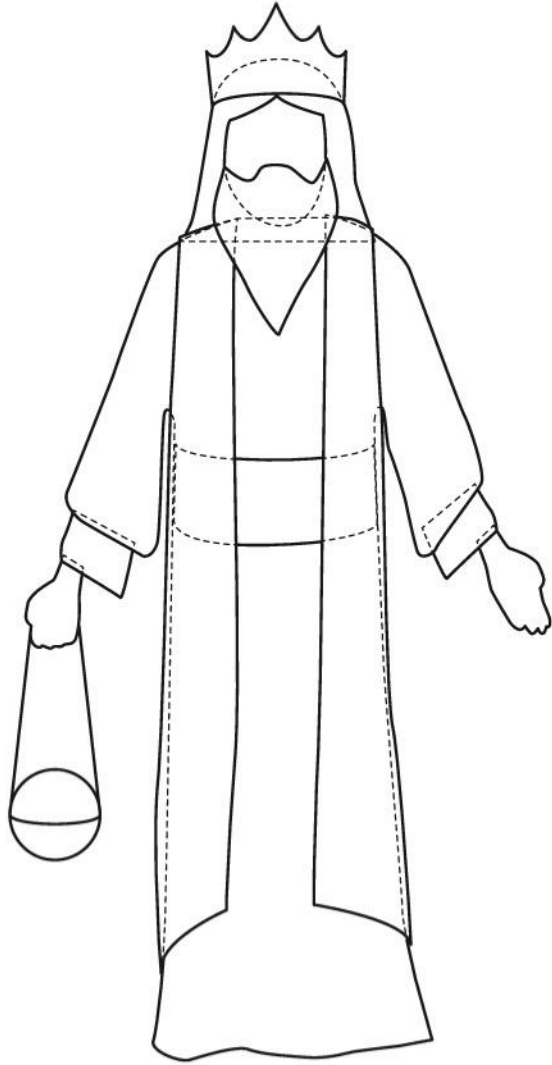

WISE MAN

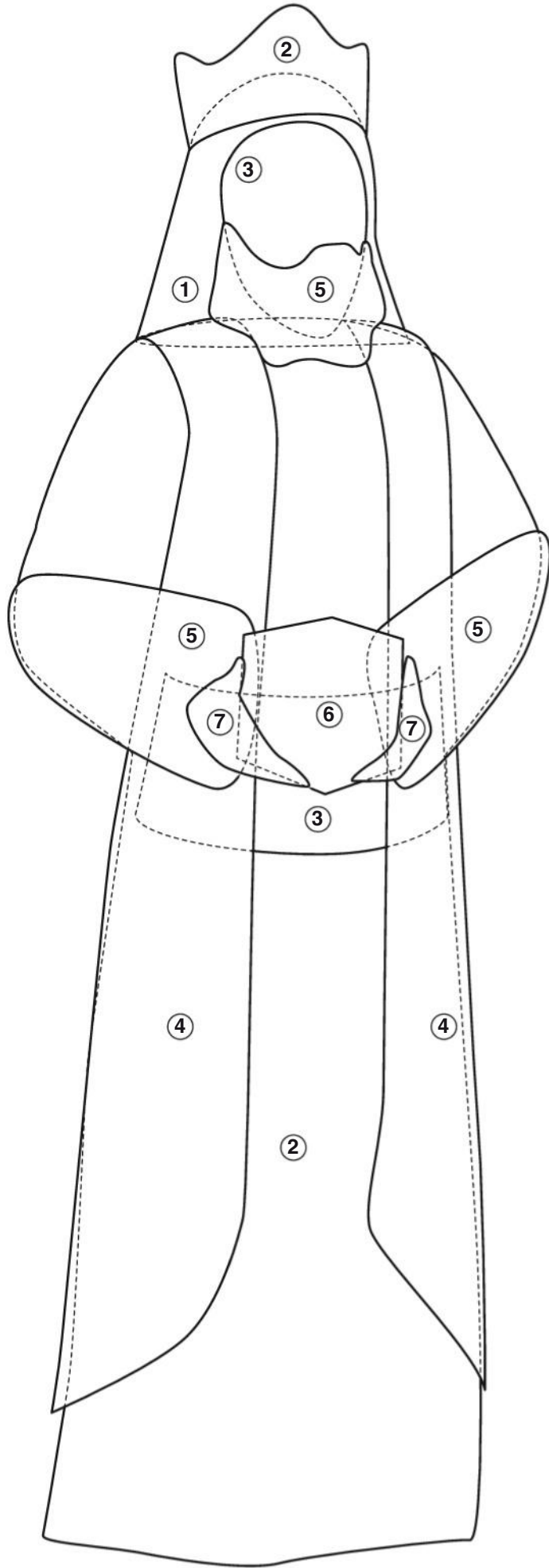

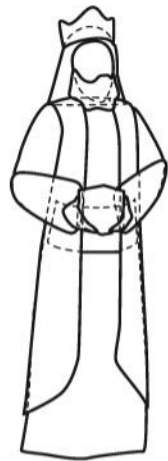
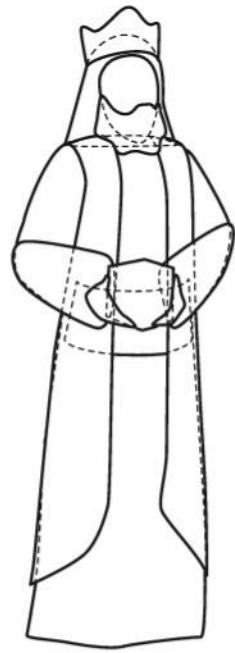
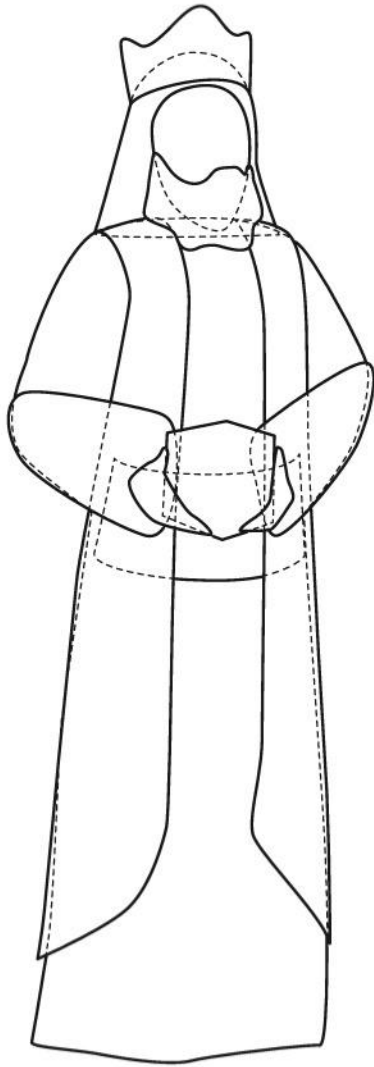

WISE MAN

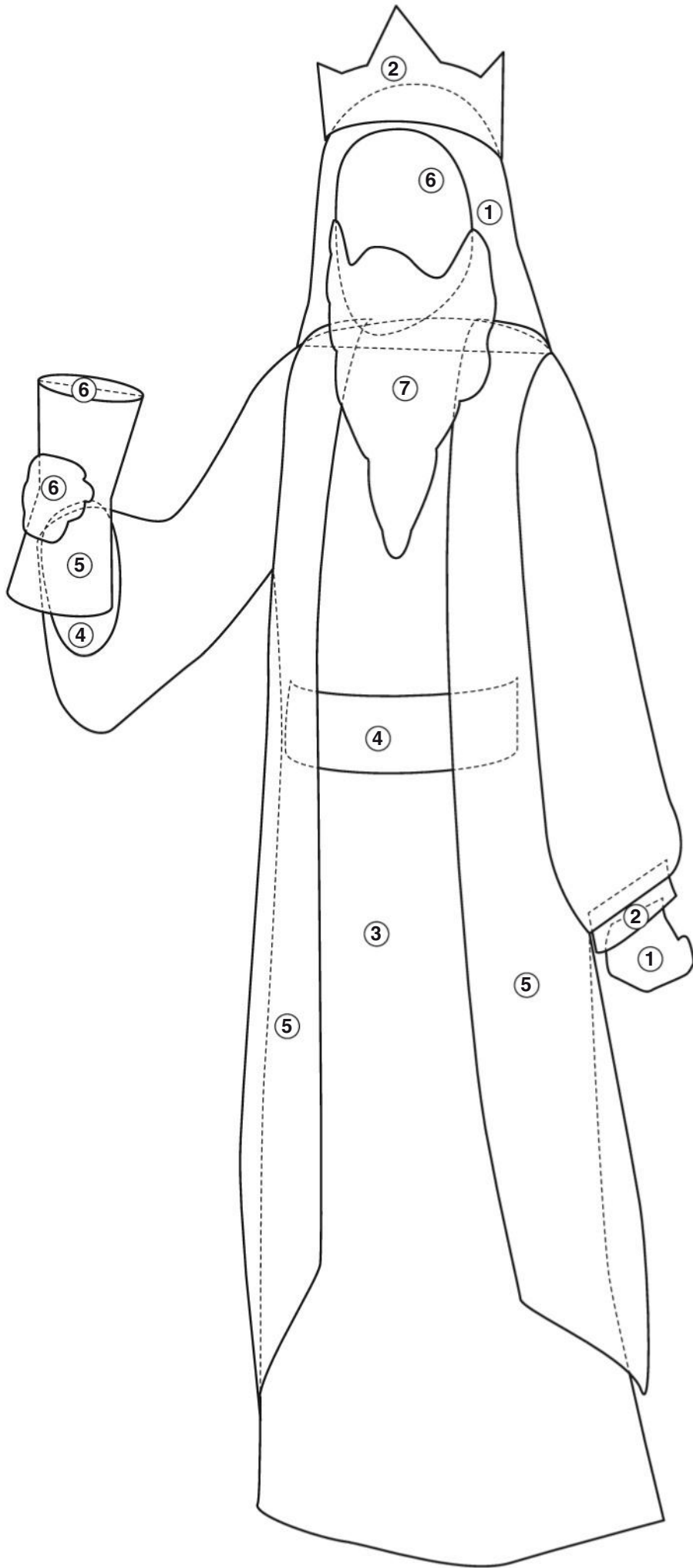



ANGEL

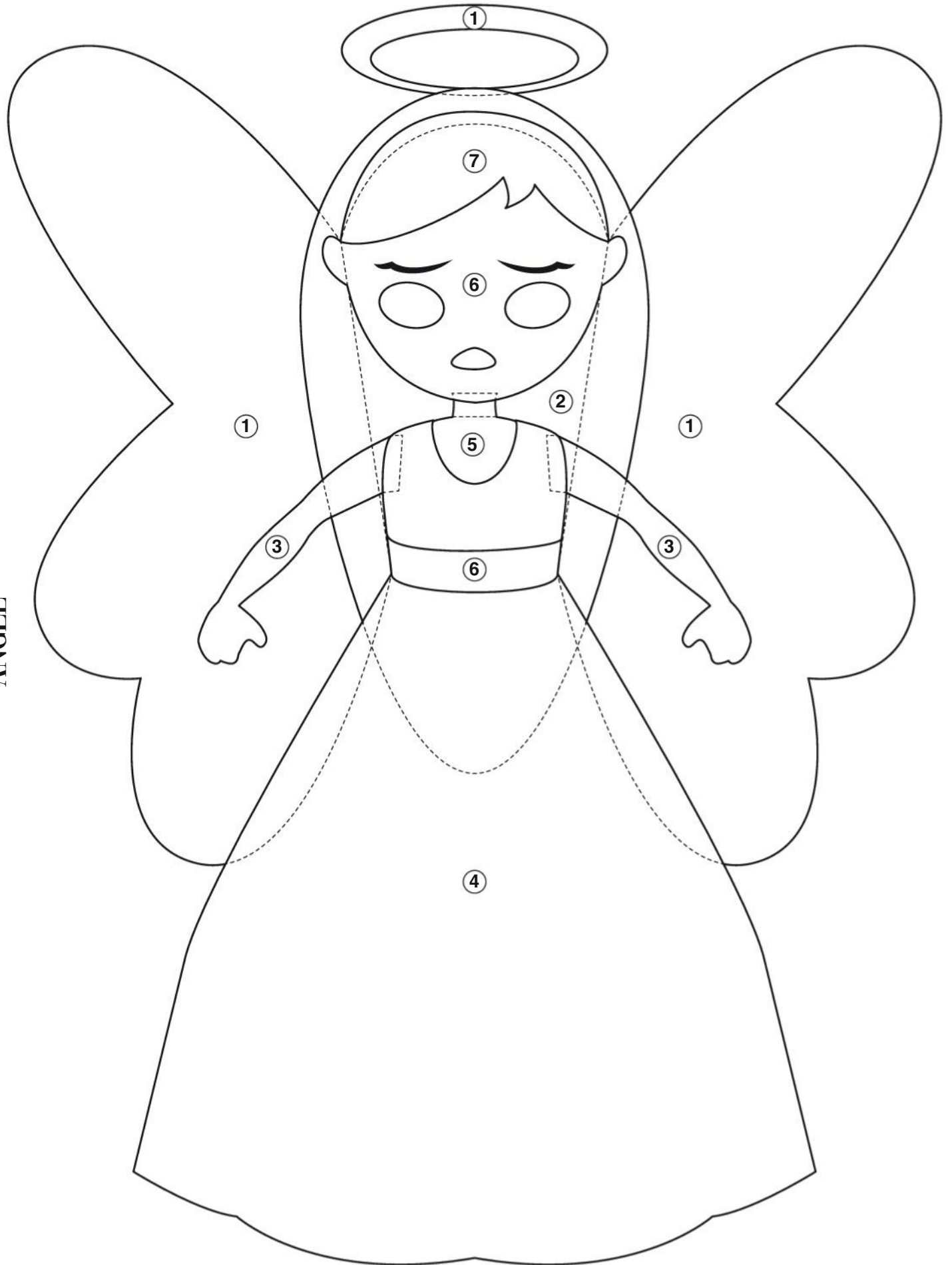

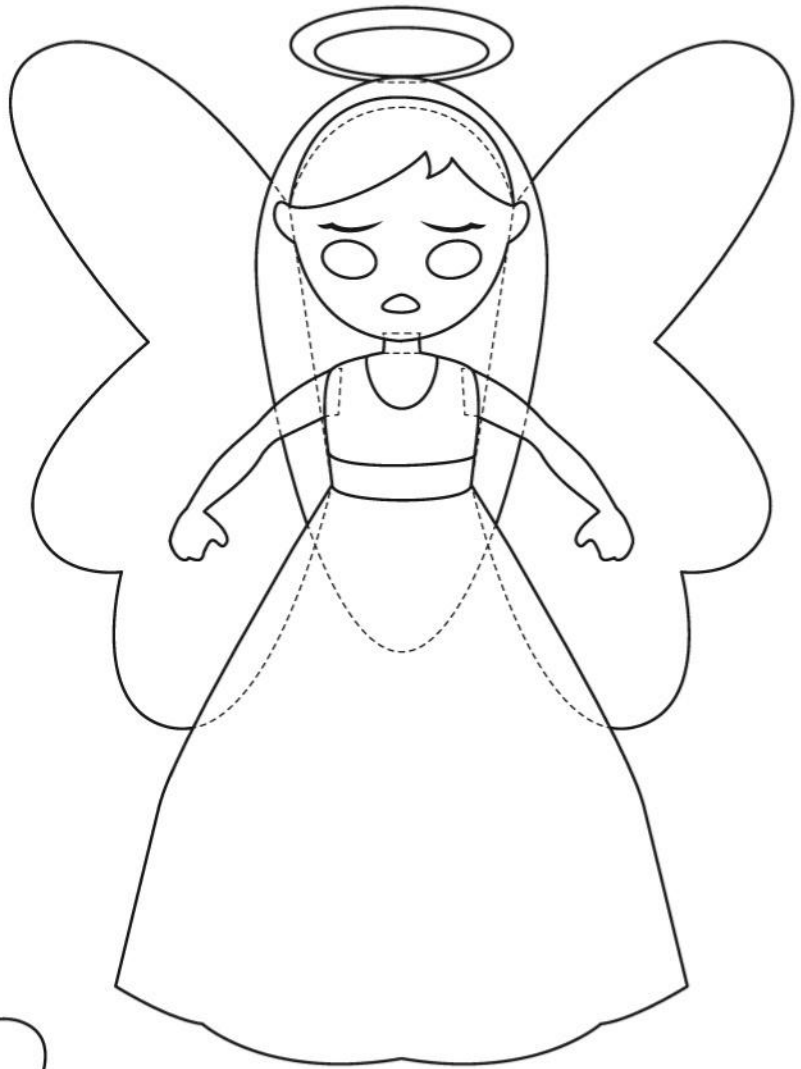

BAUBLE

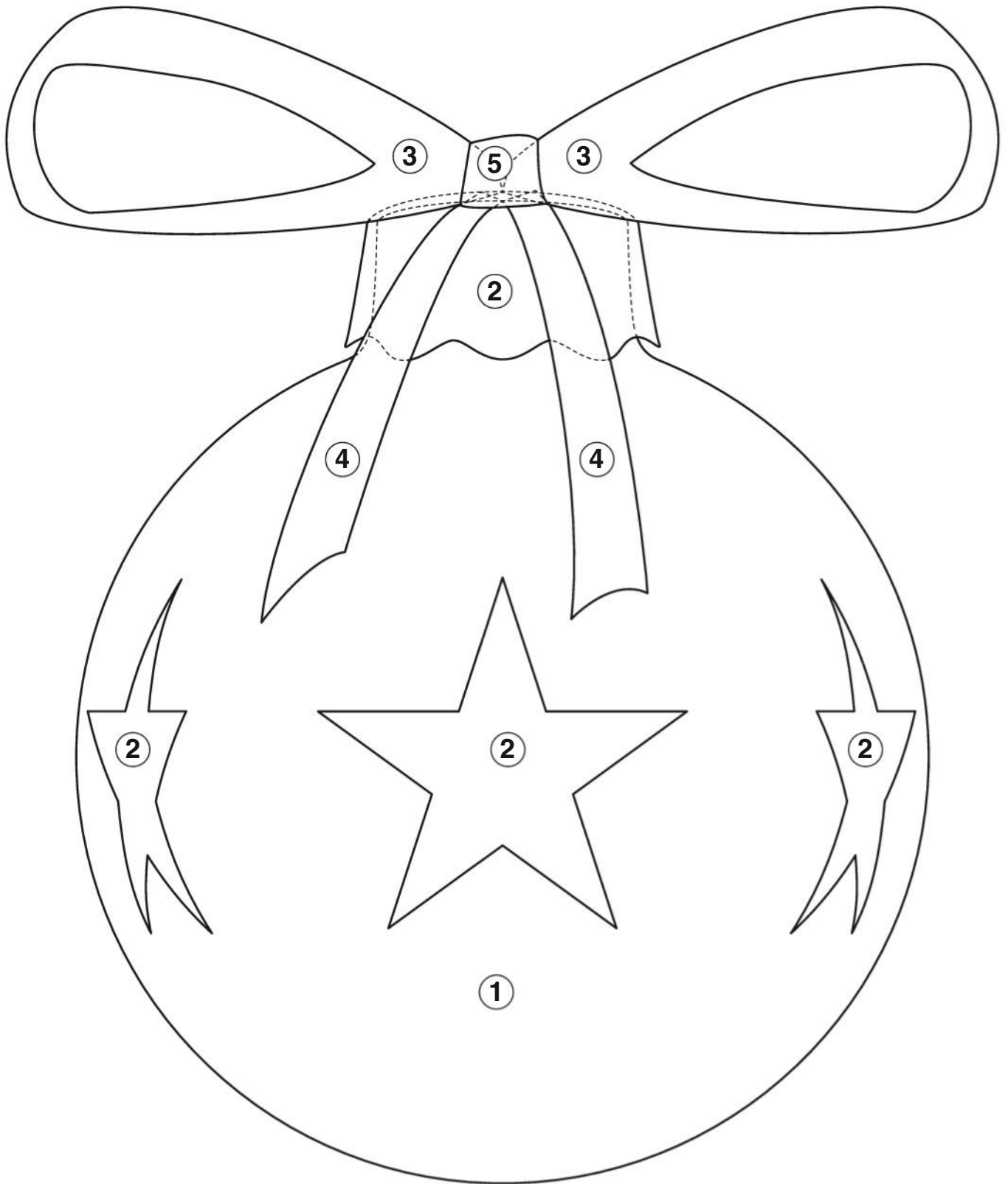

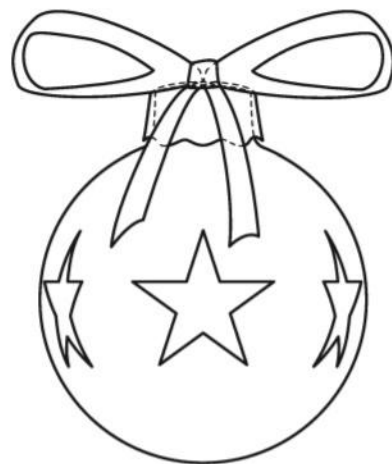
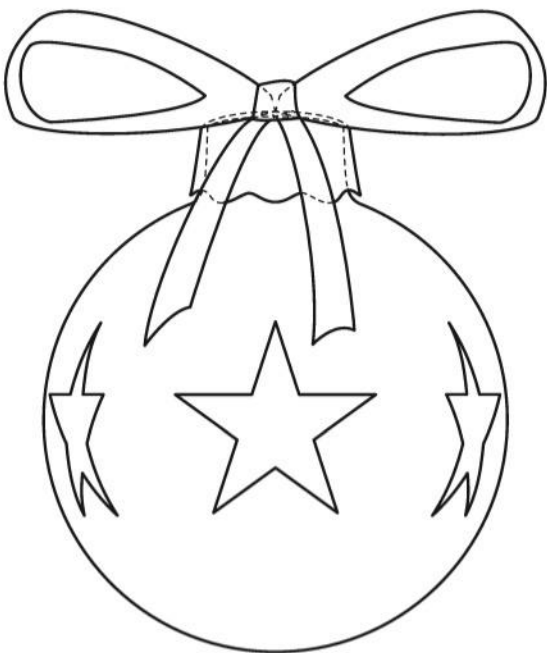
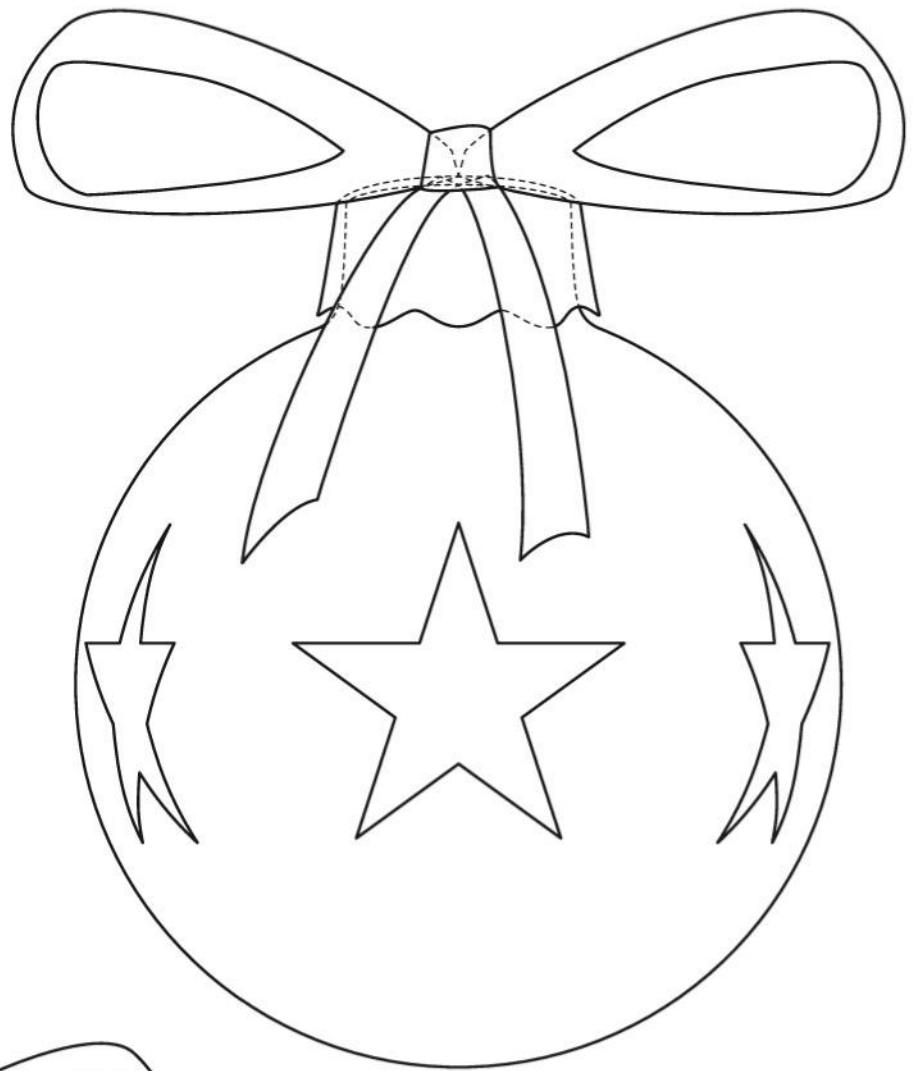

BELL

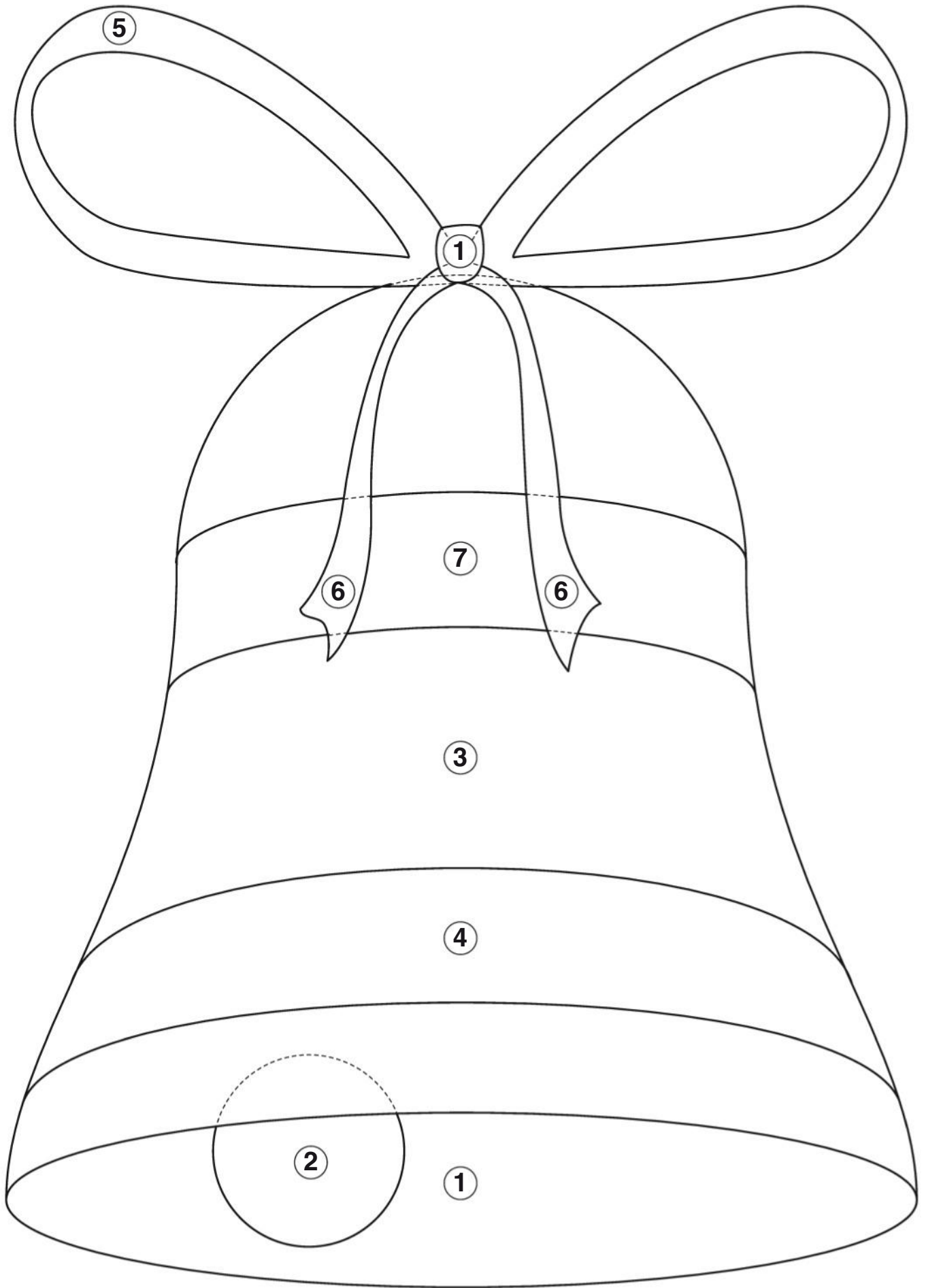

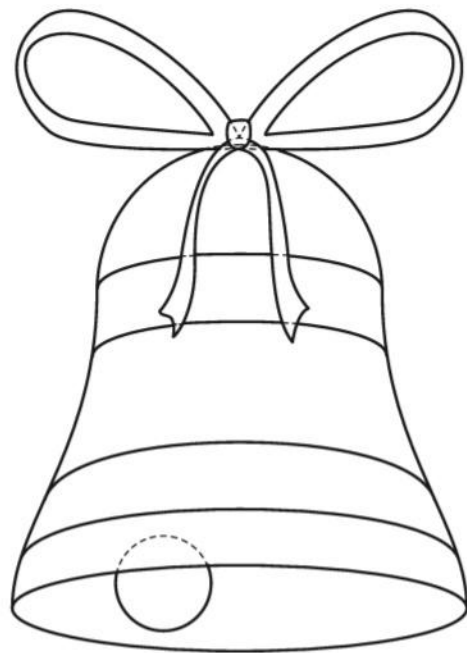
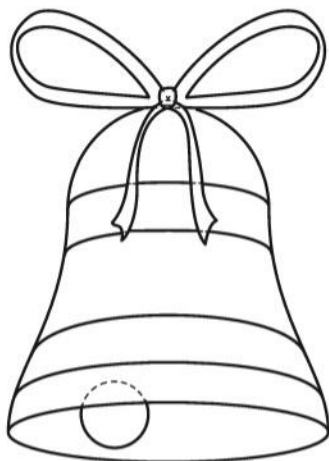
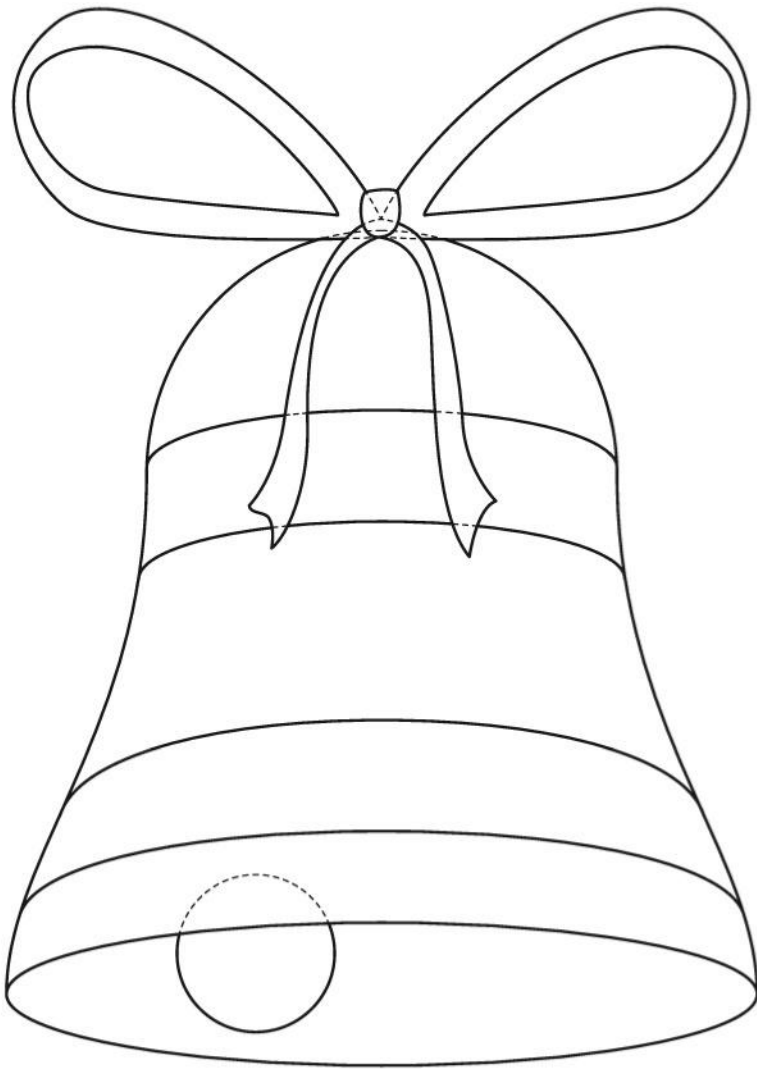

CANDLE

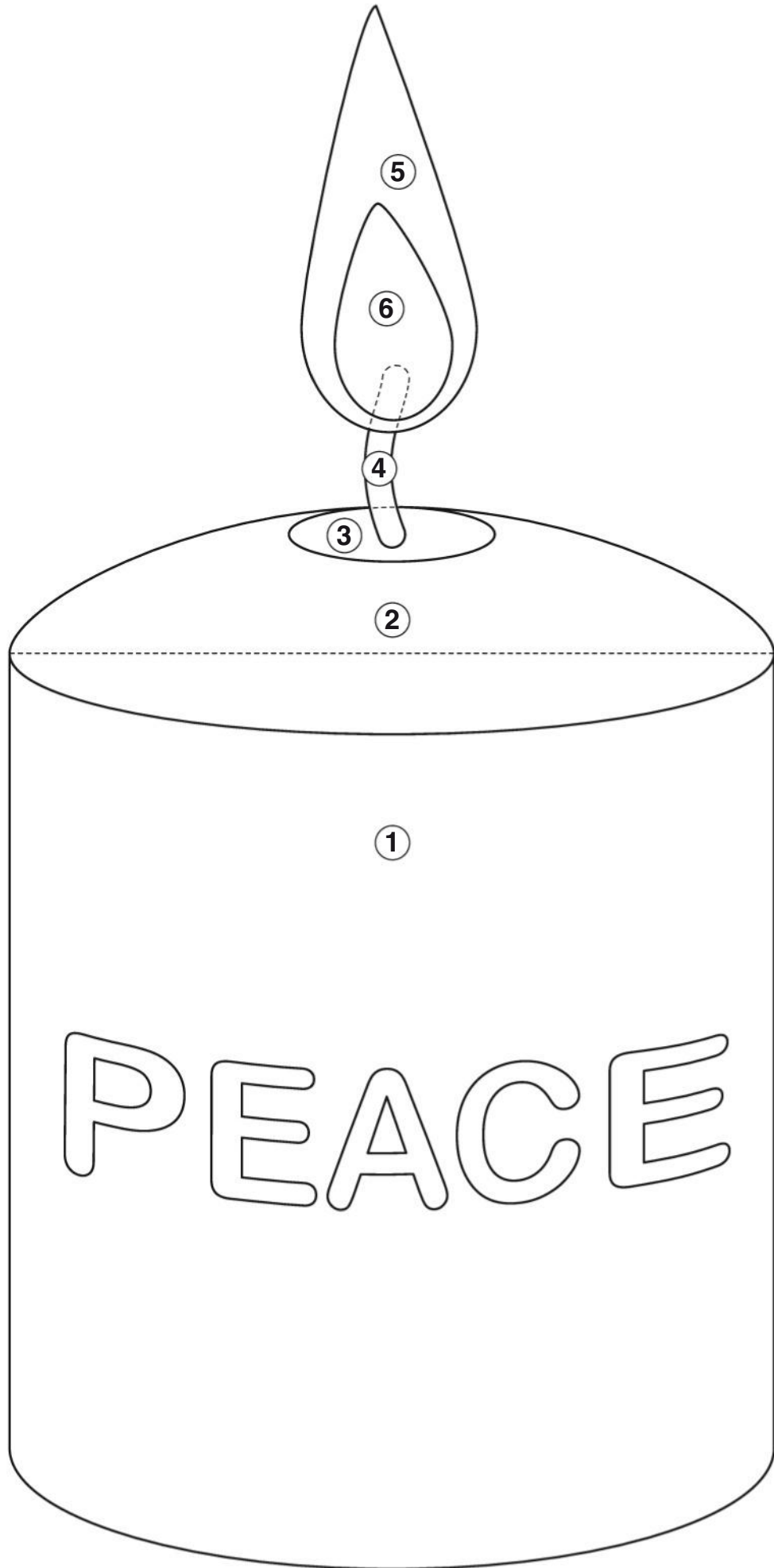



GINGERBREAD HOUSE

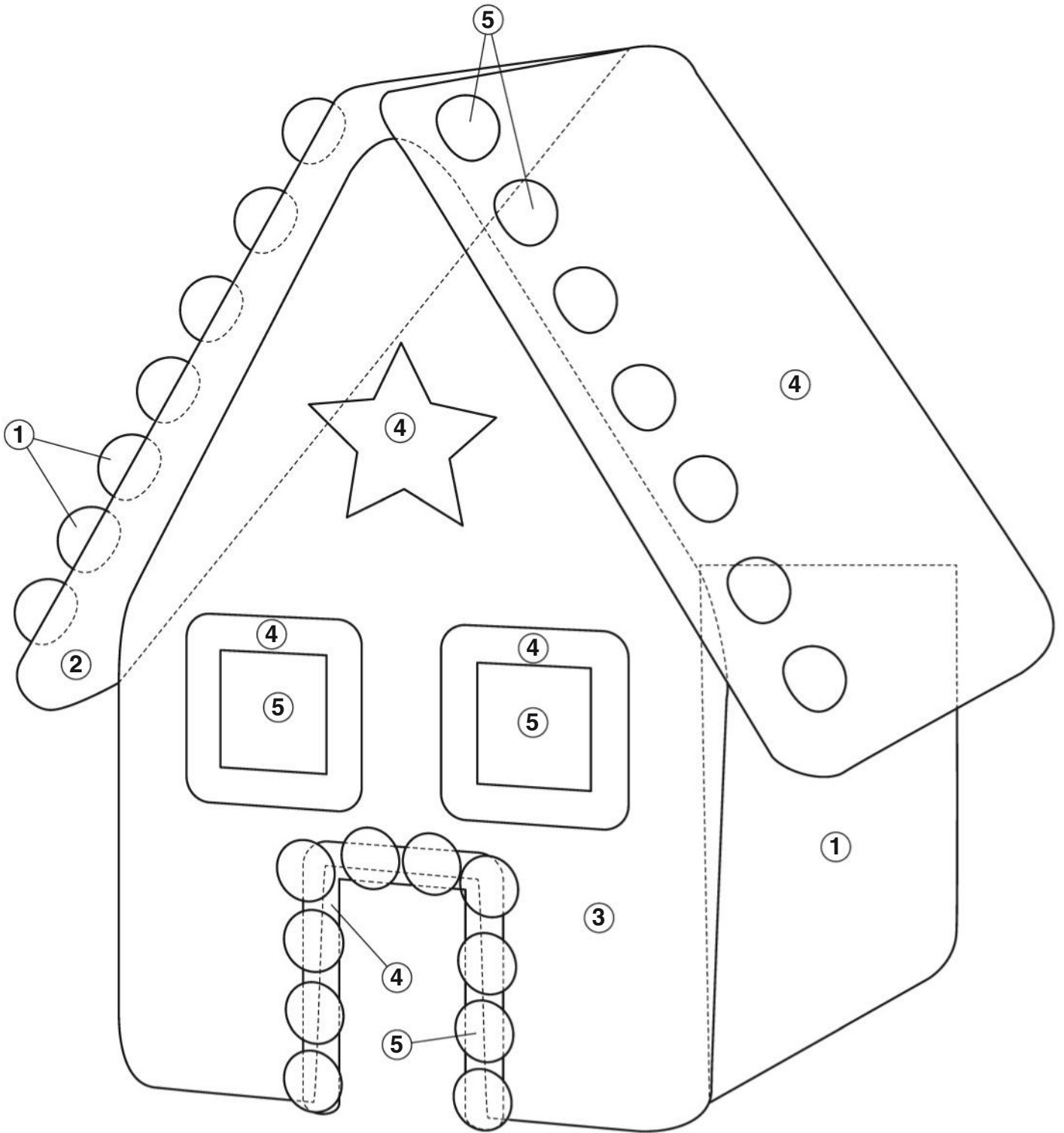

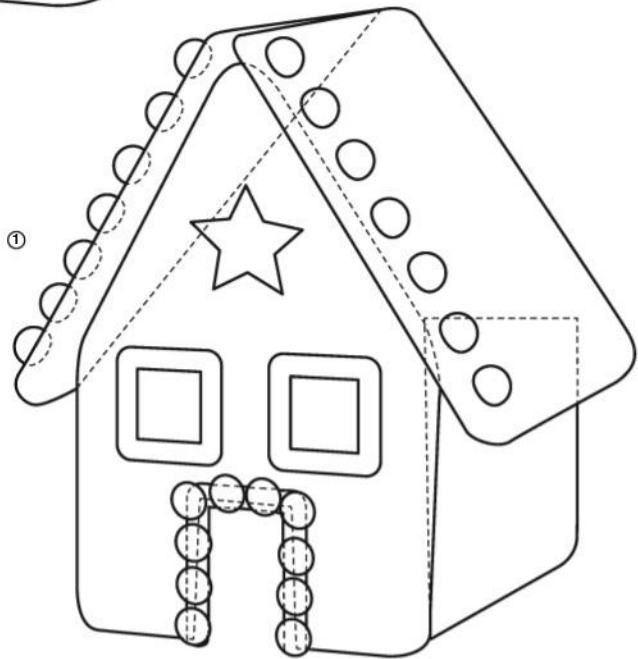
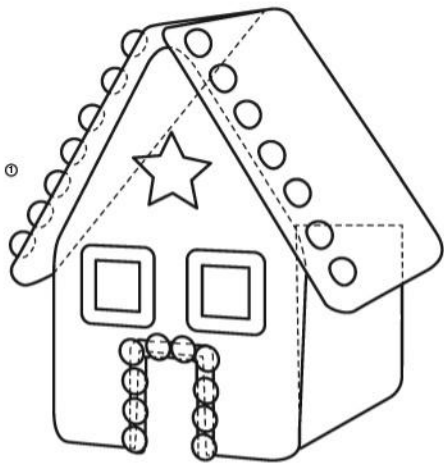
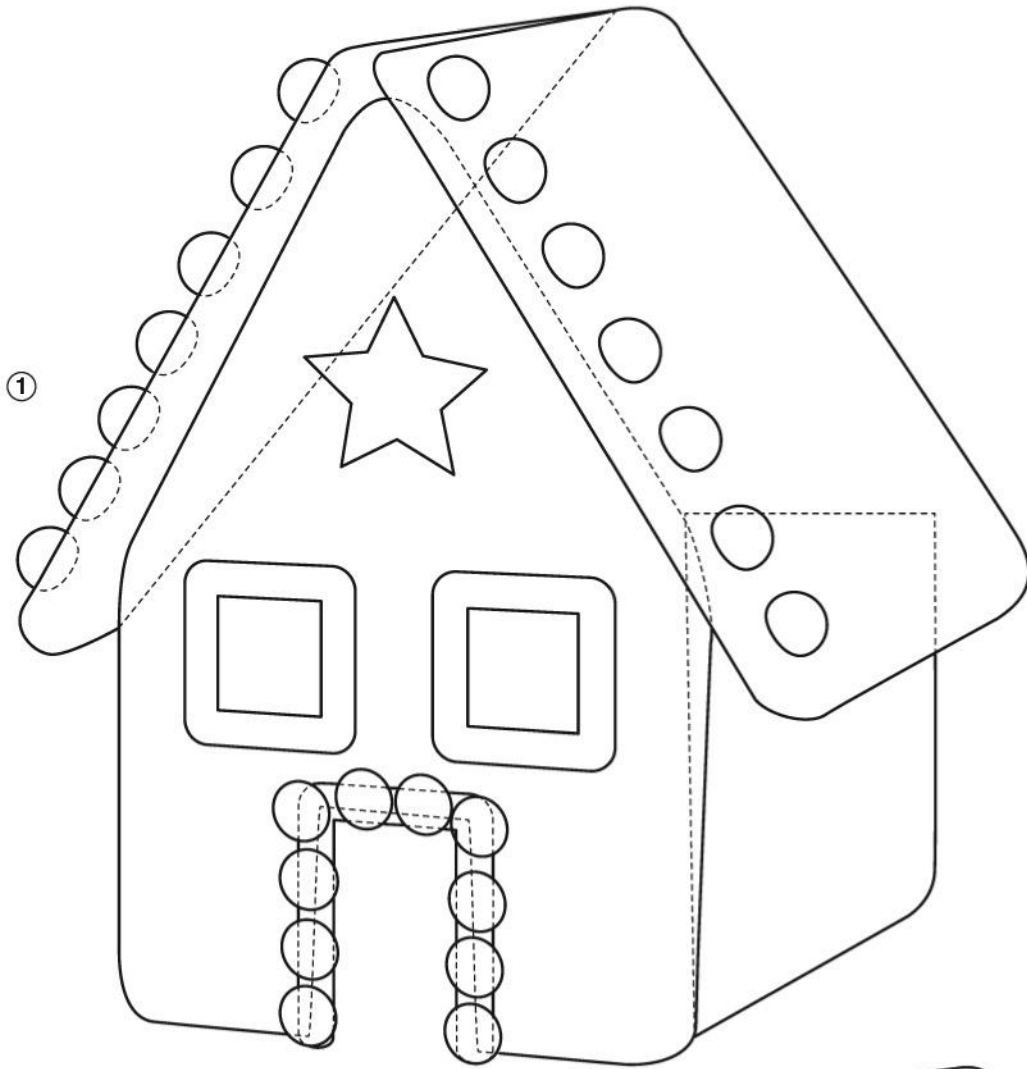

SWEETS

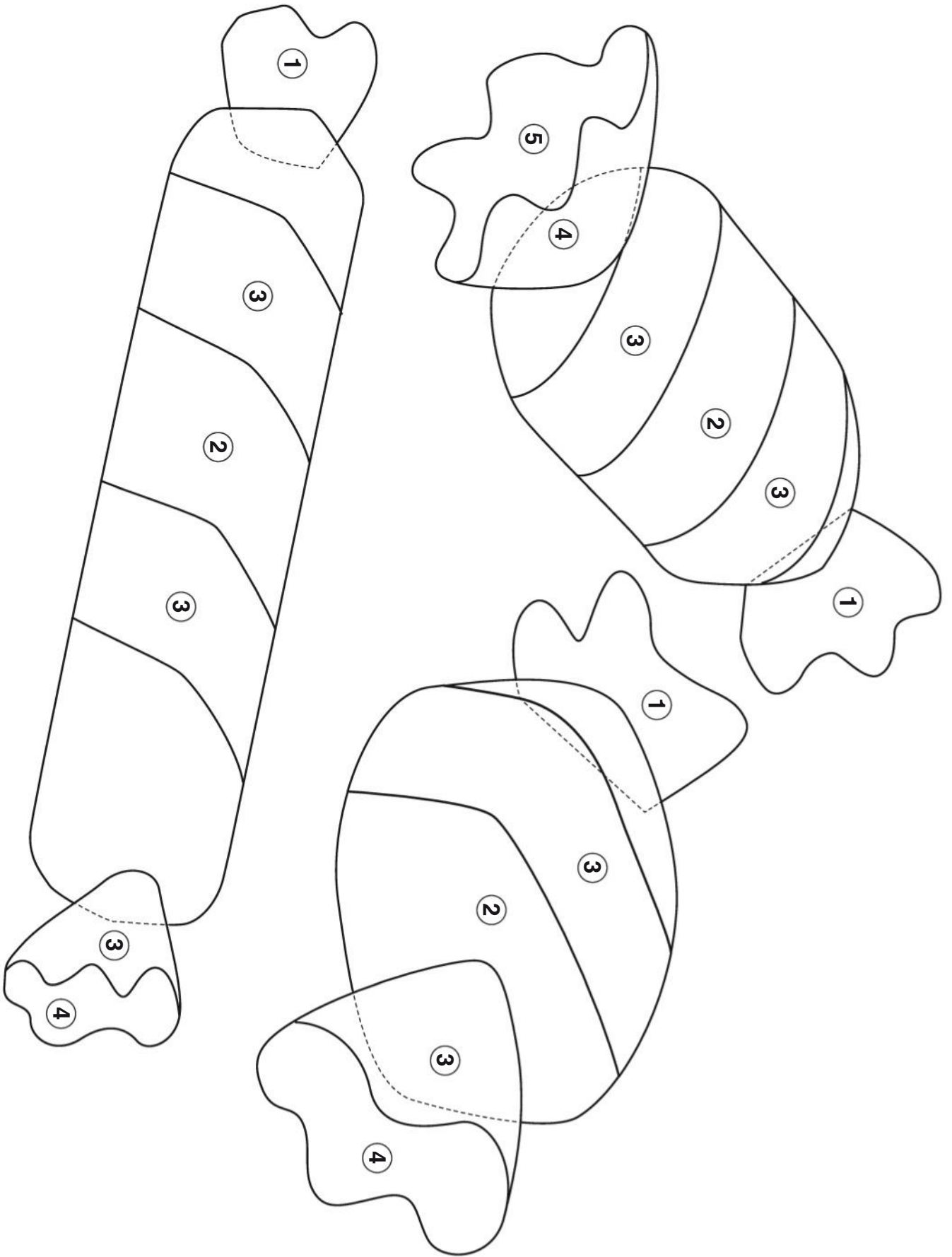

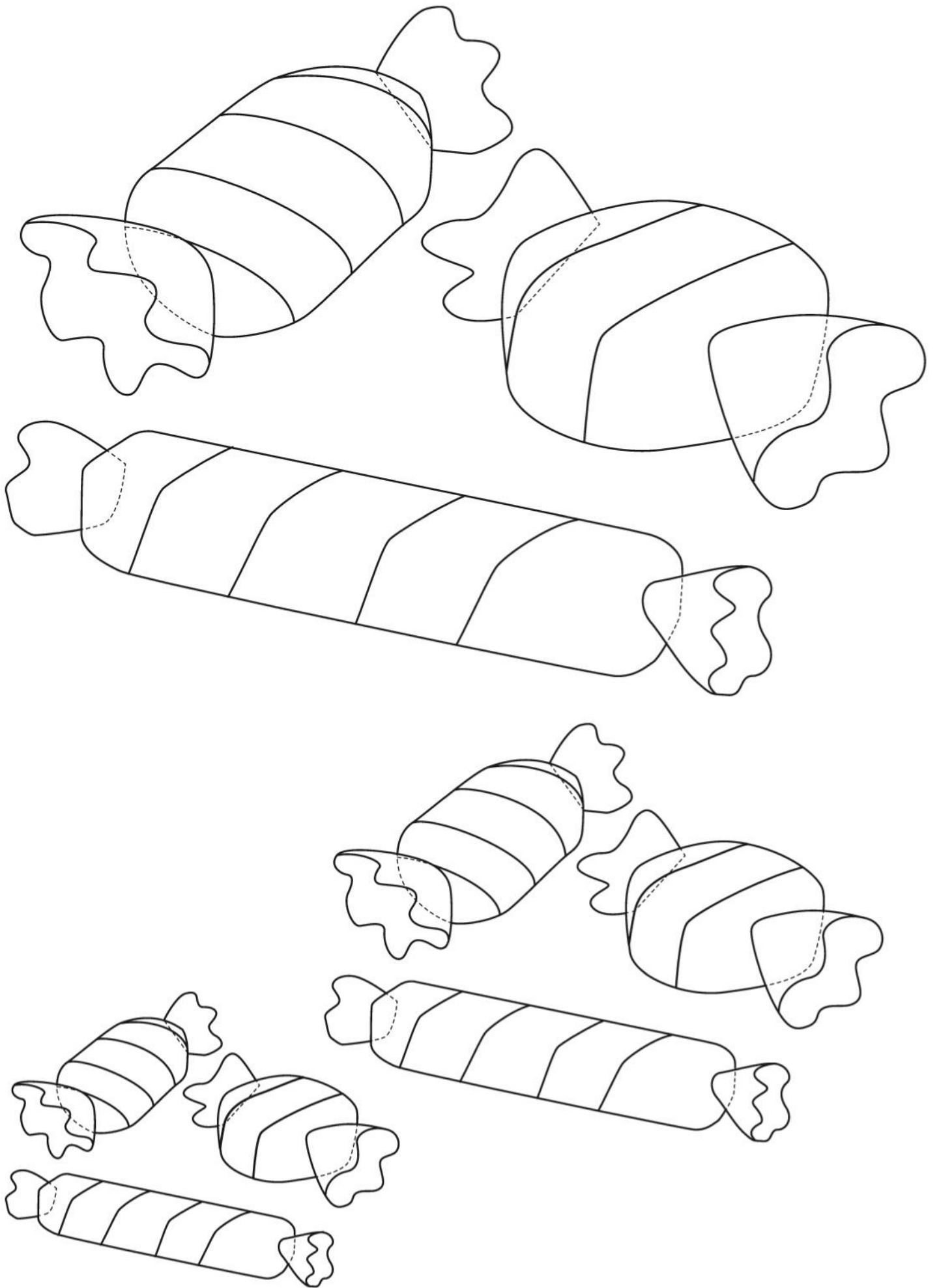

ROBIN

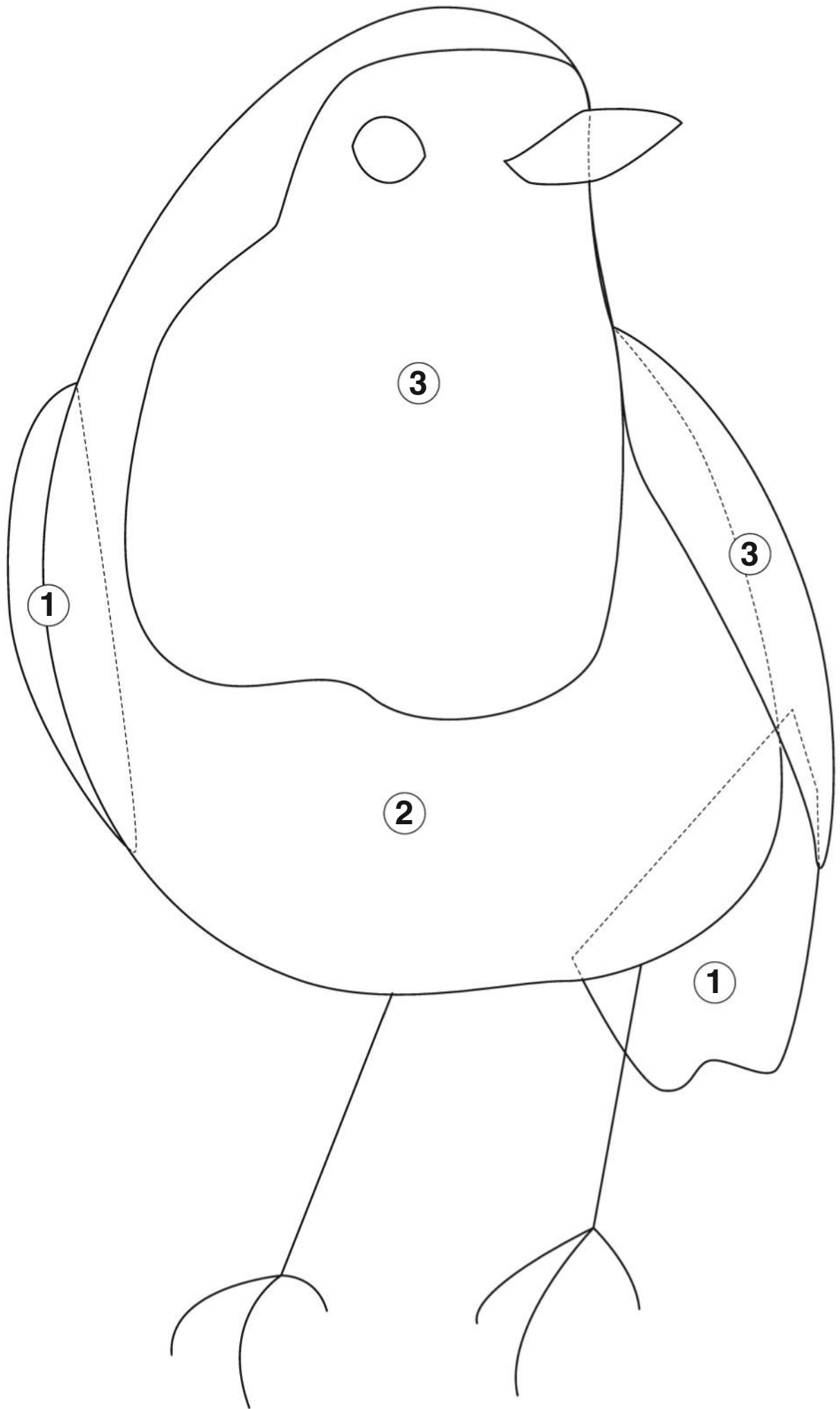

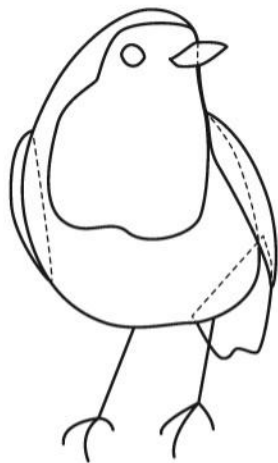
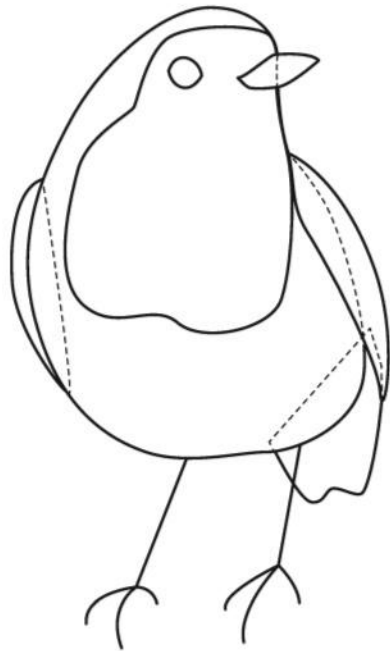
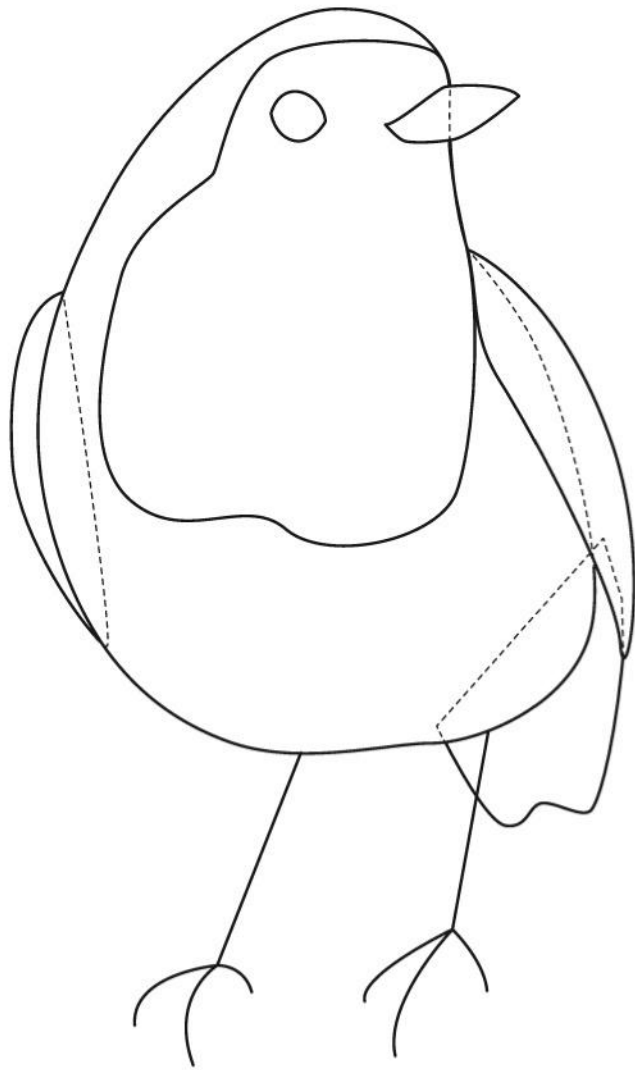

CAKE

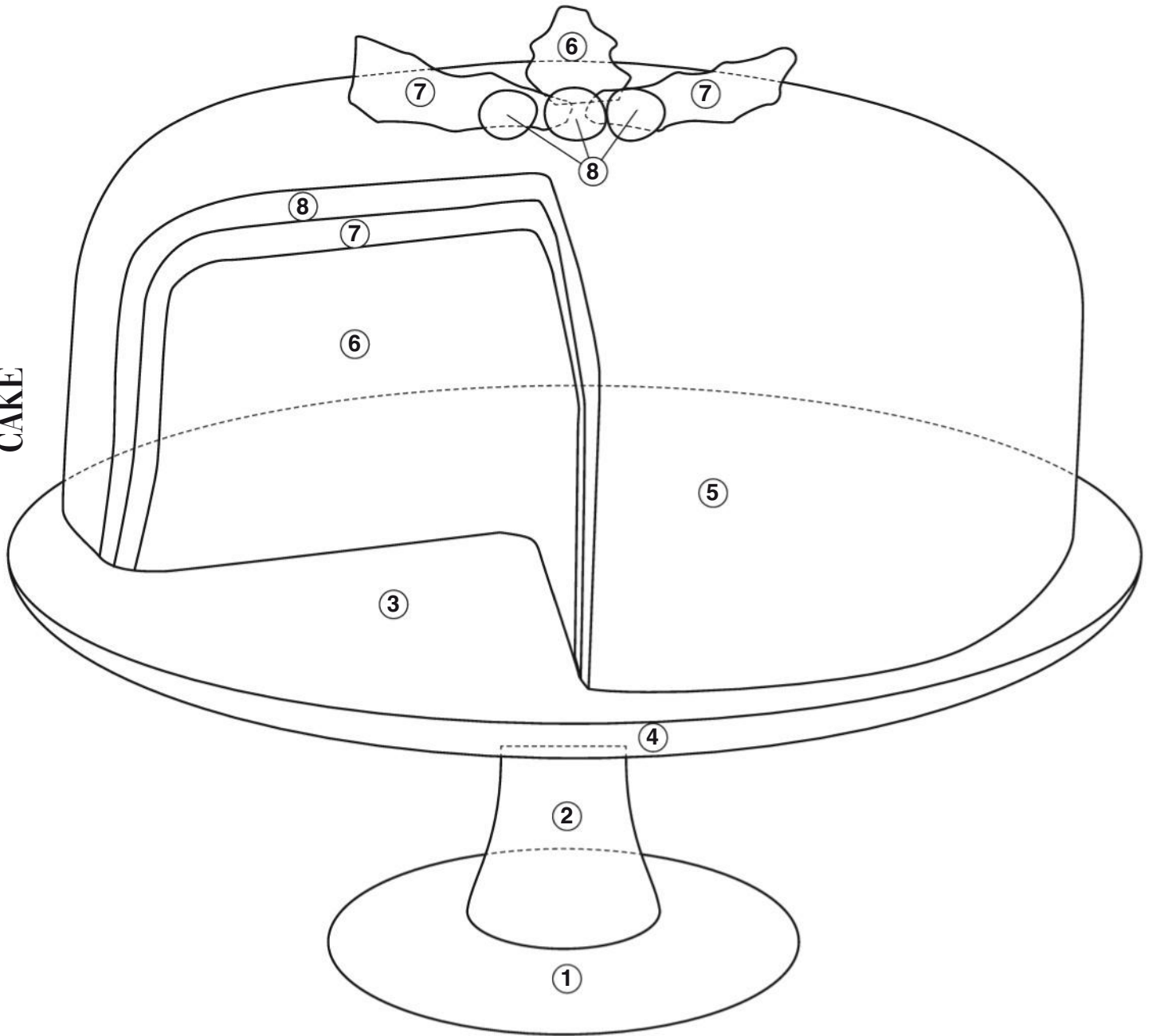

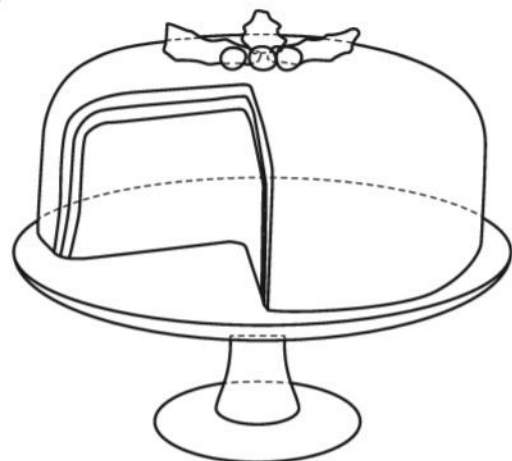
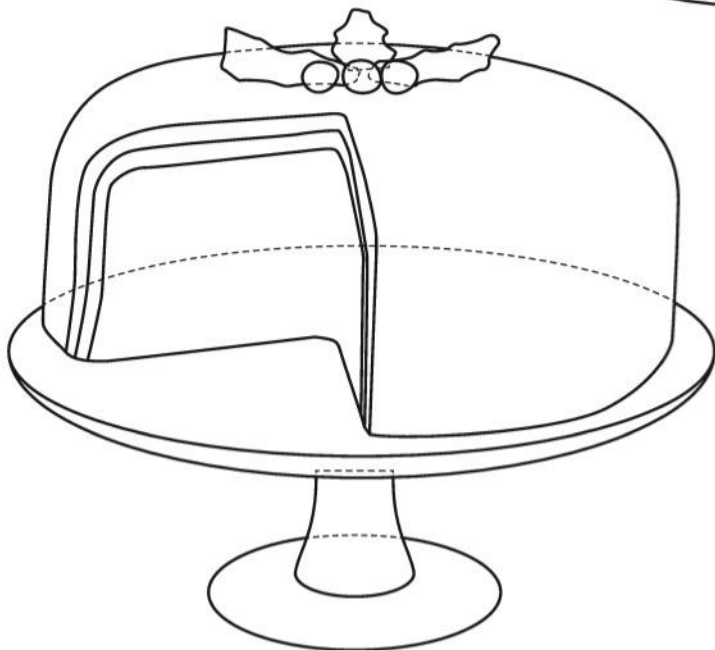
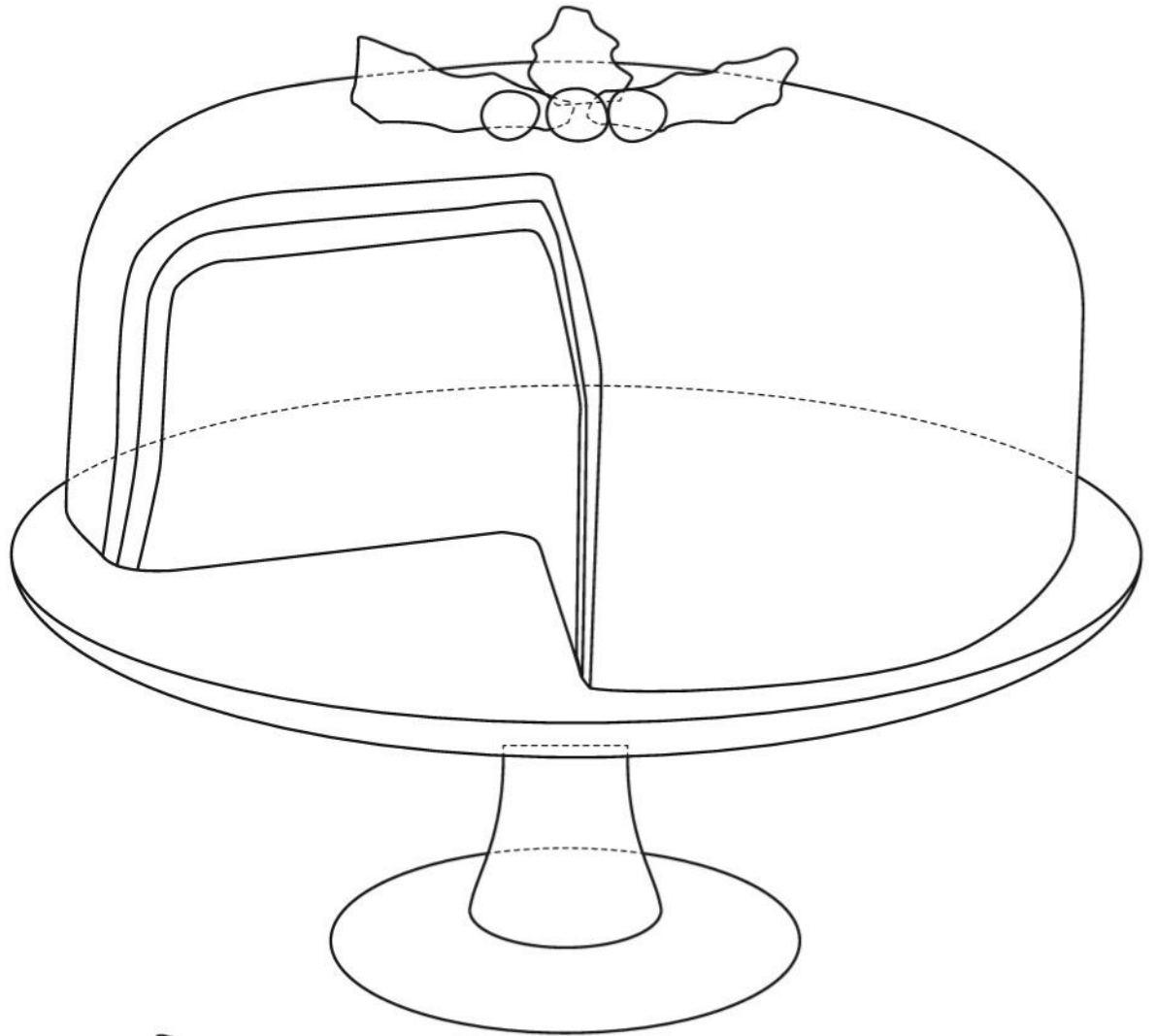

JUMPER

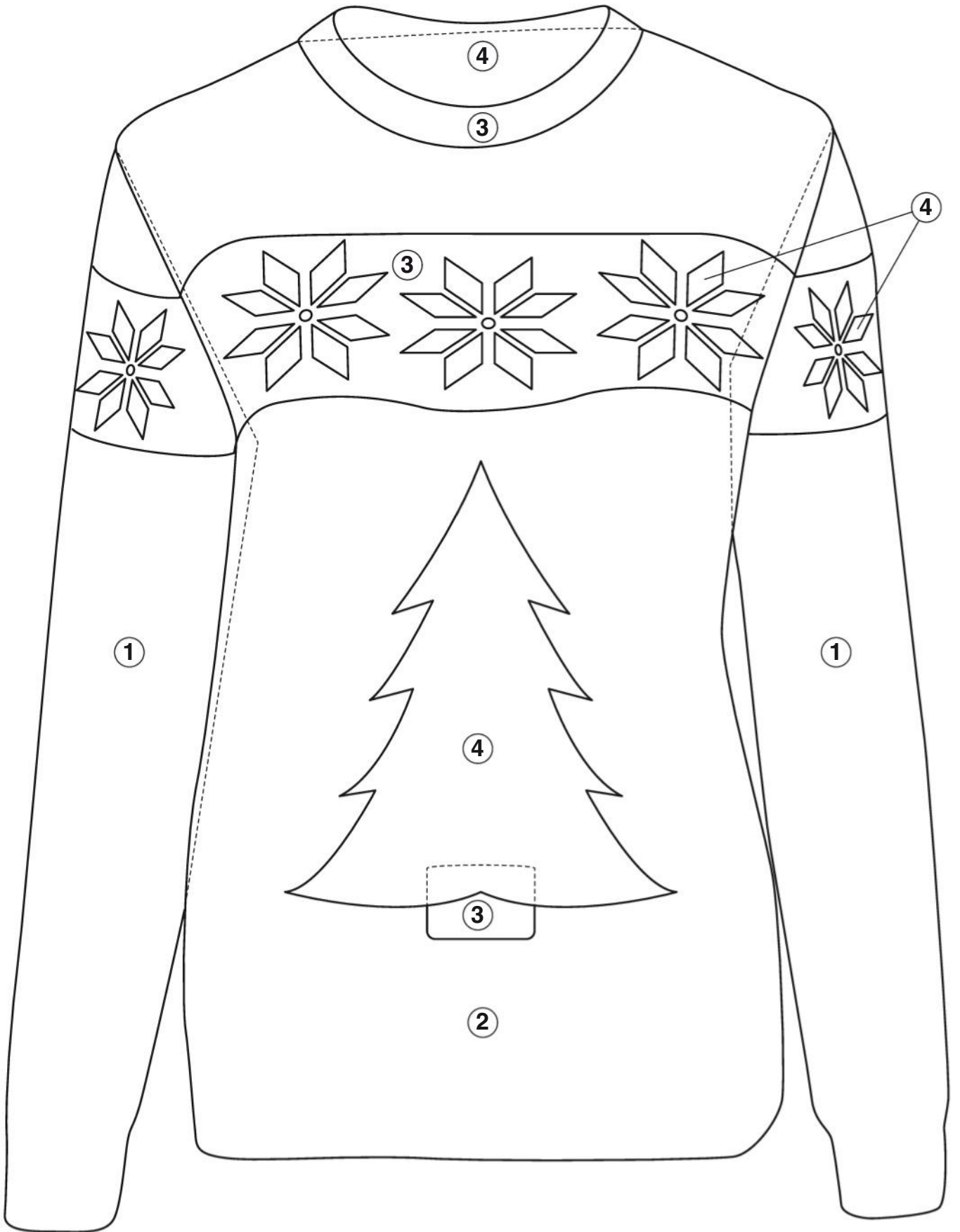



STOCKING

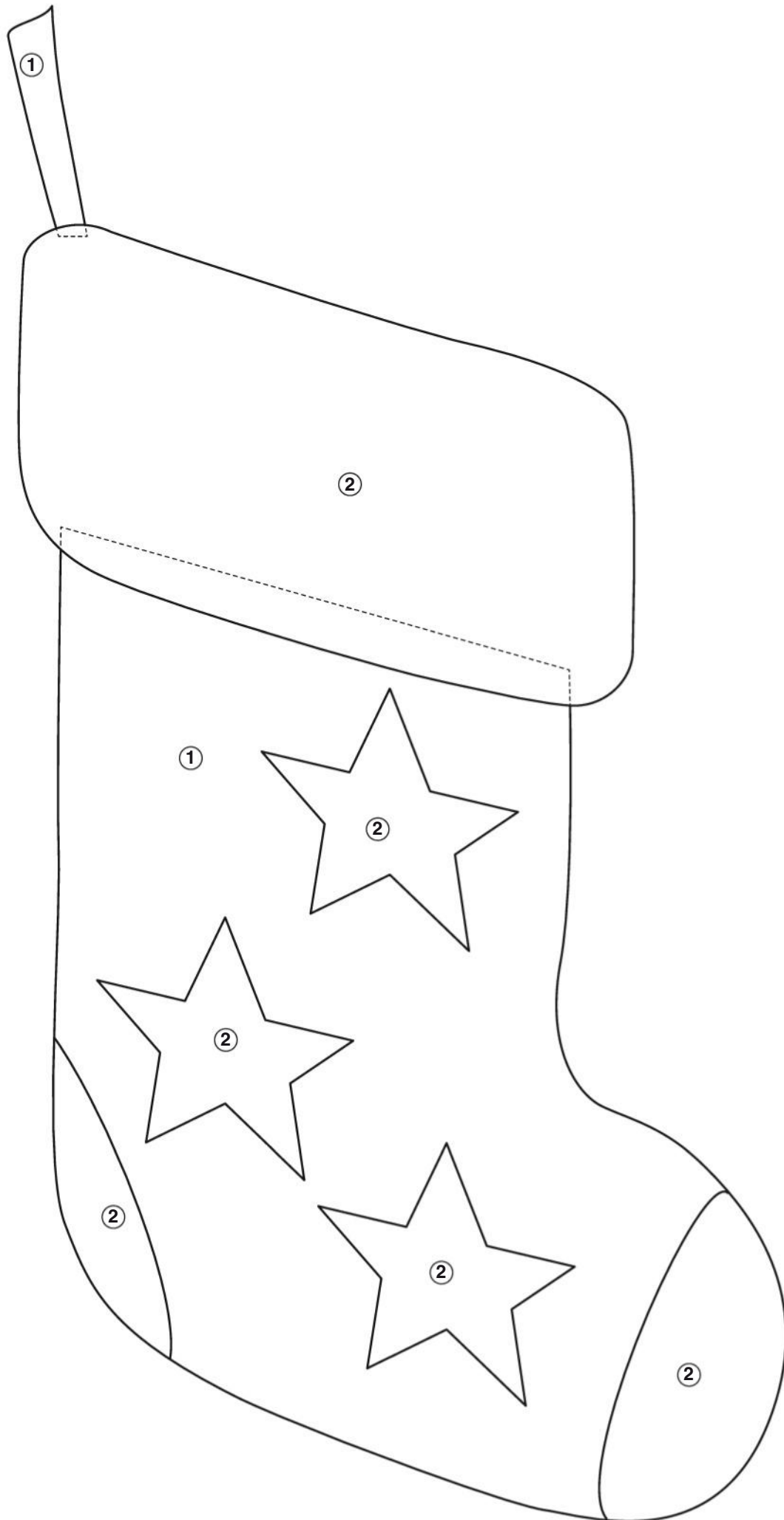

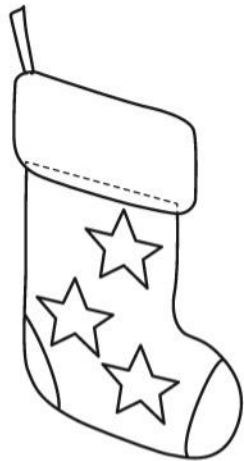
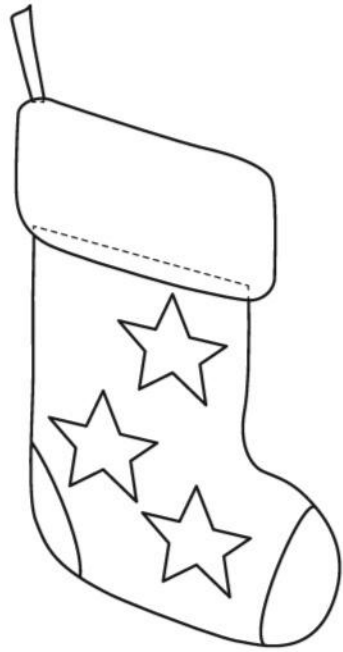
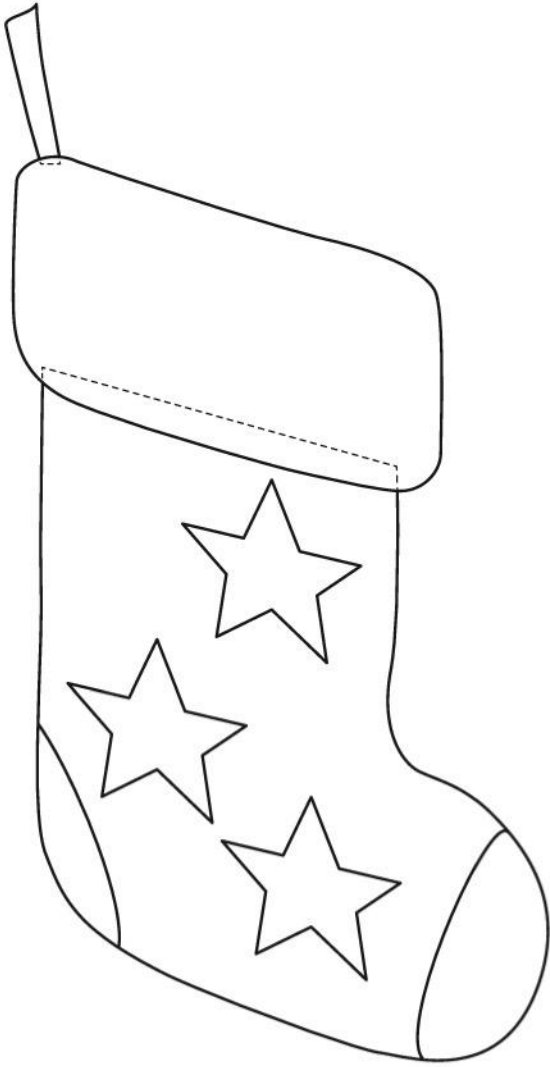

PENGUIN

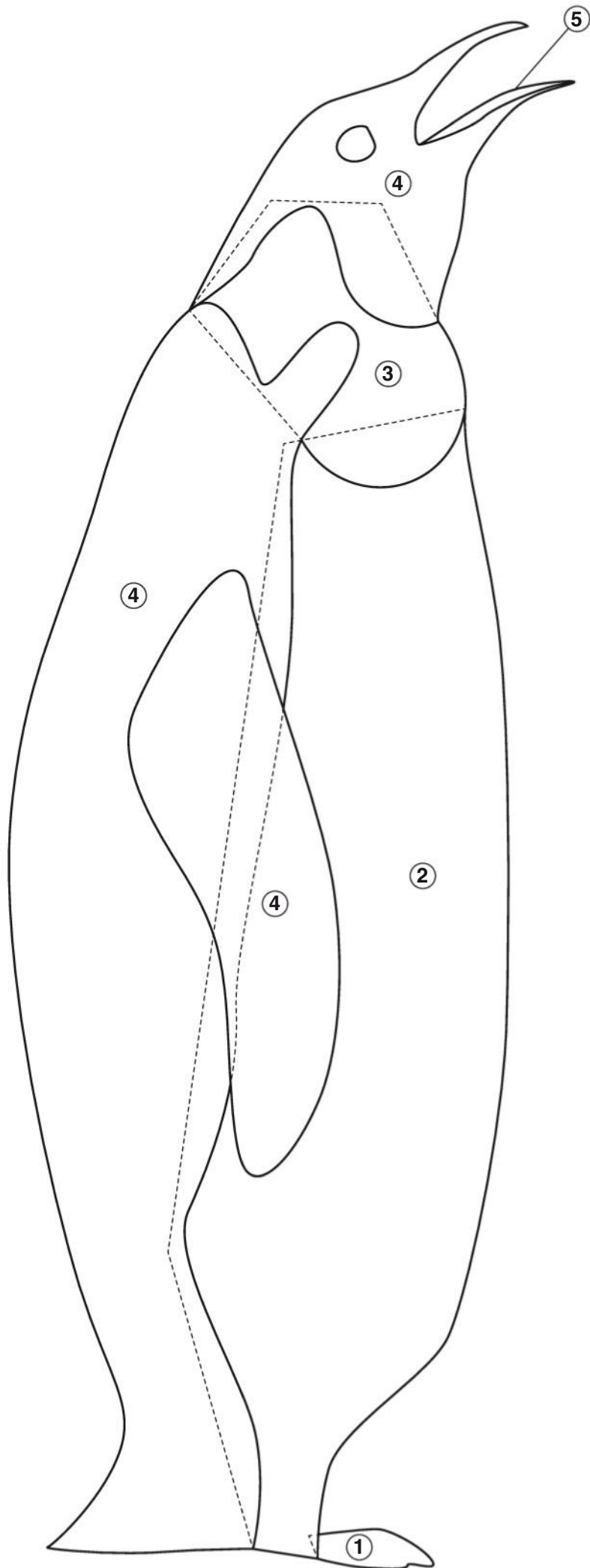

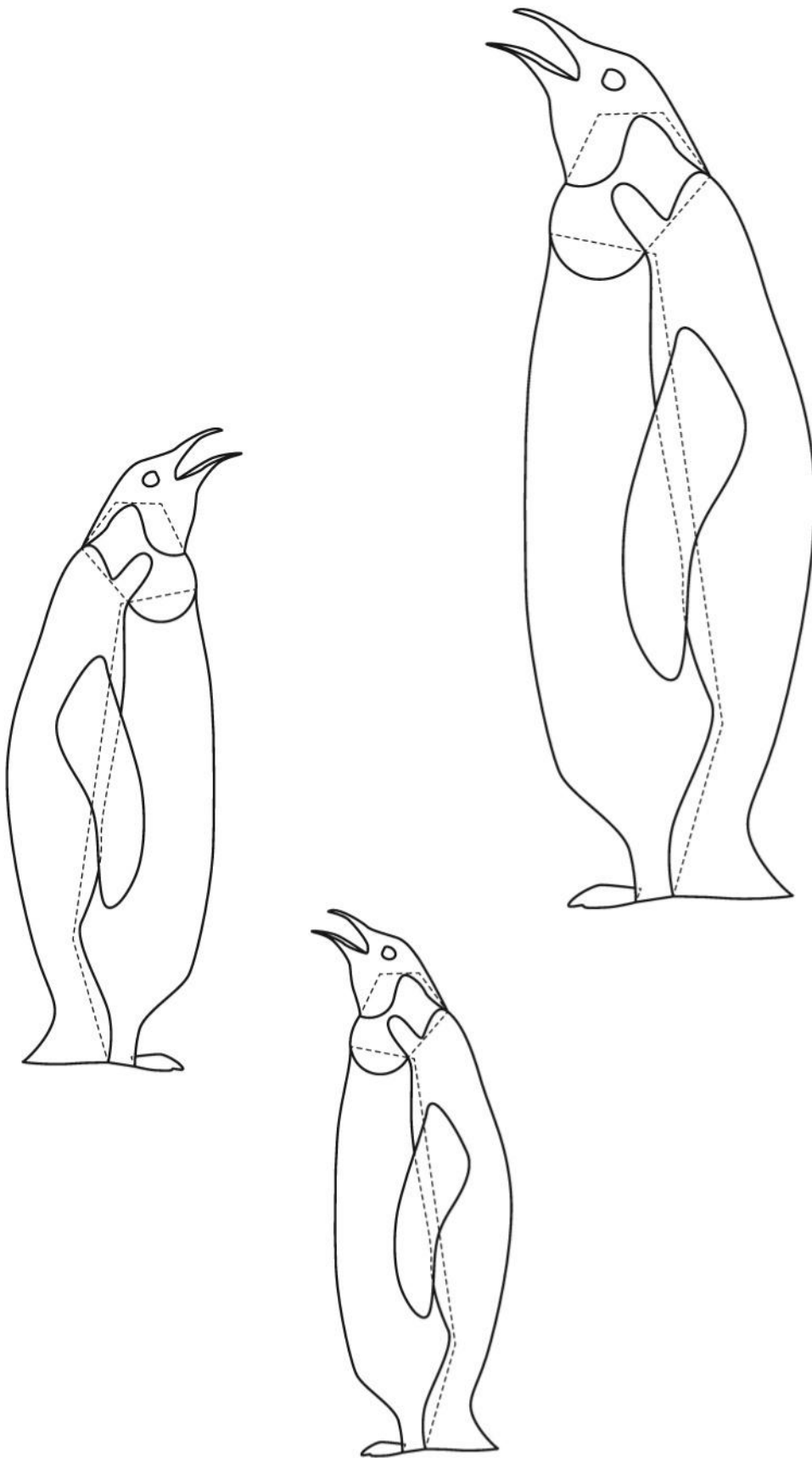

CRACKER

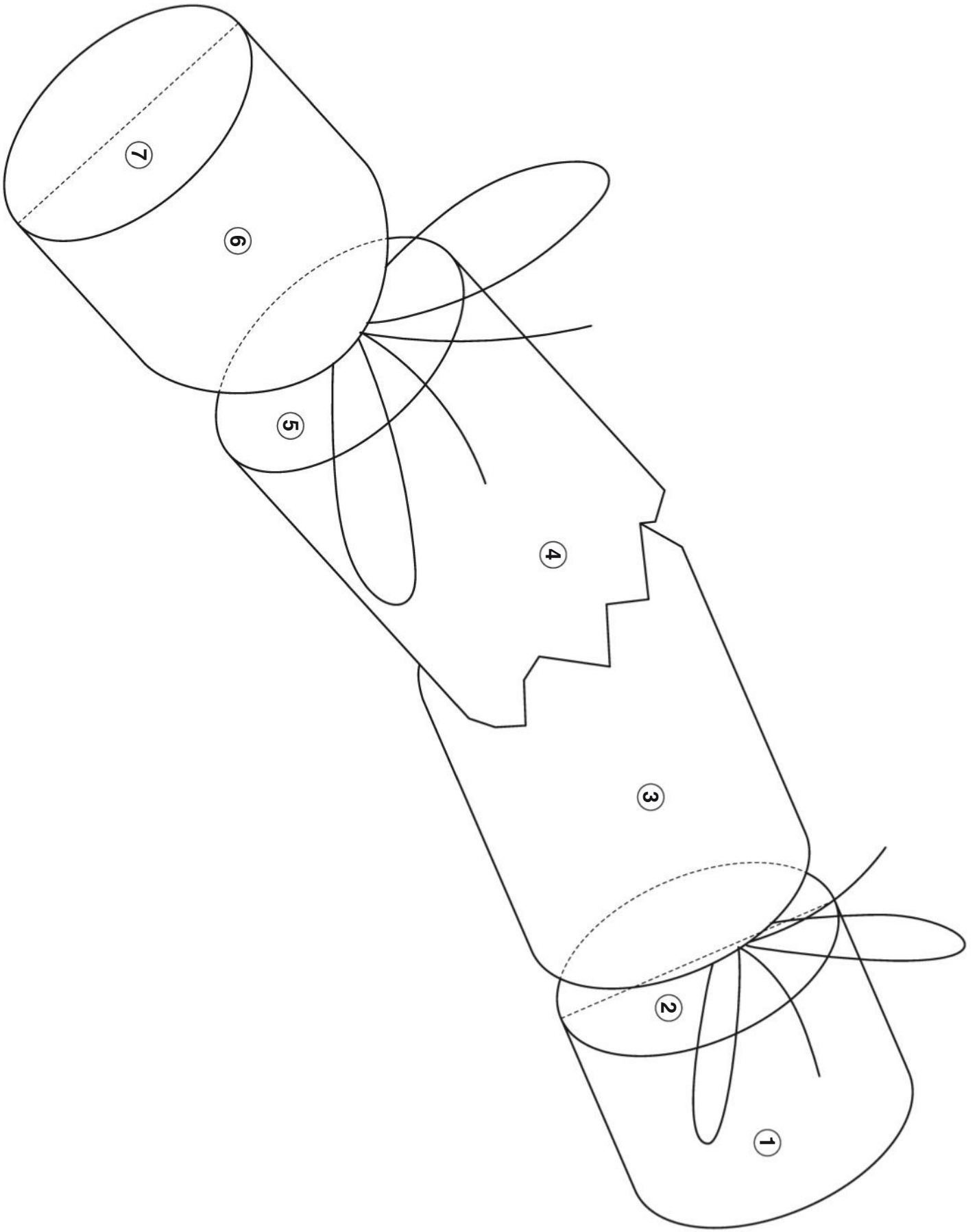

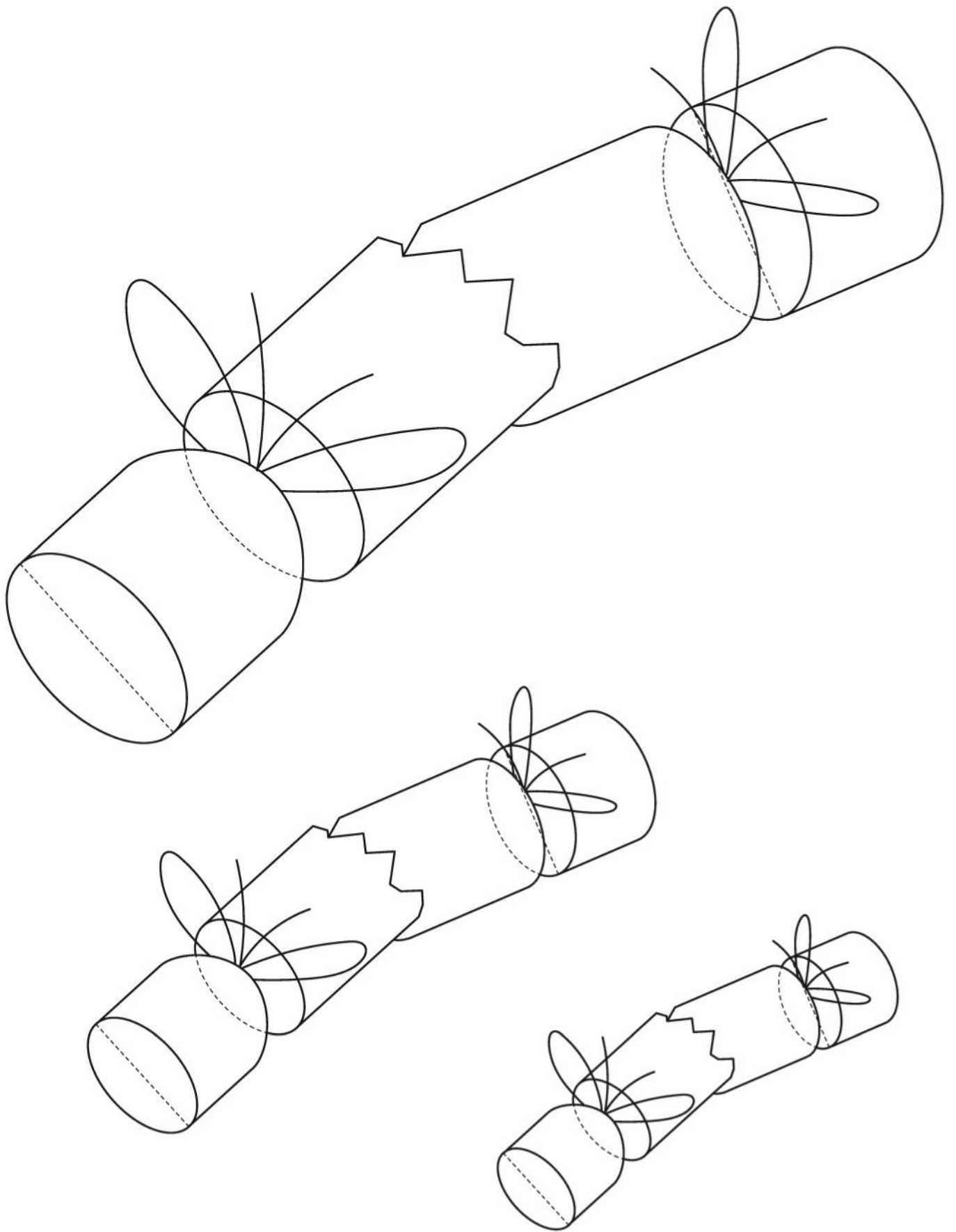

STARS

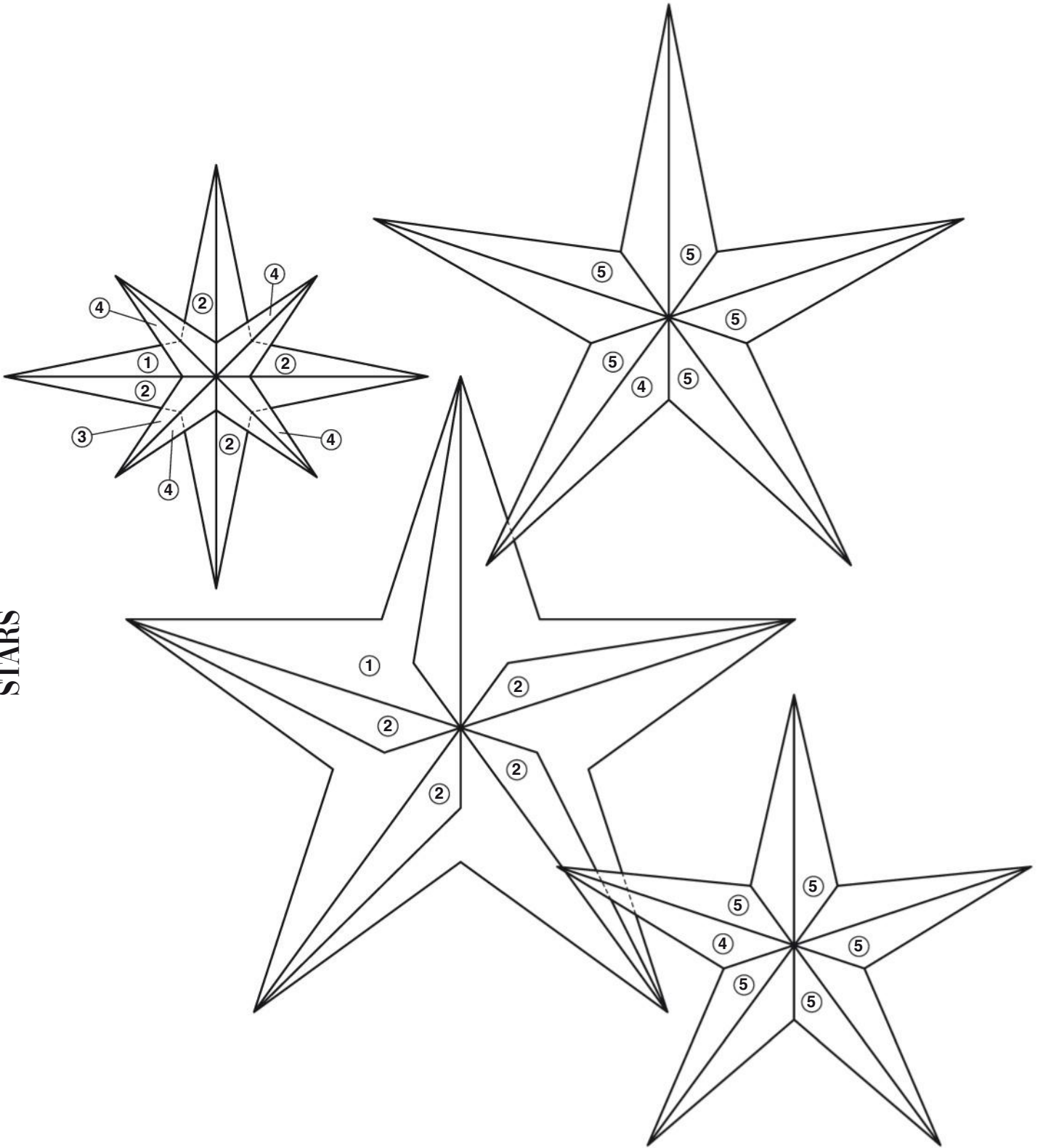

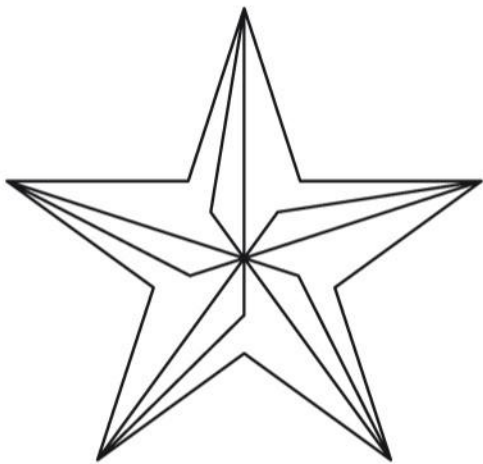
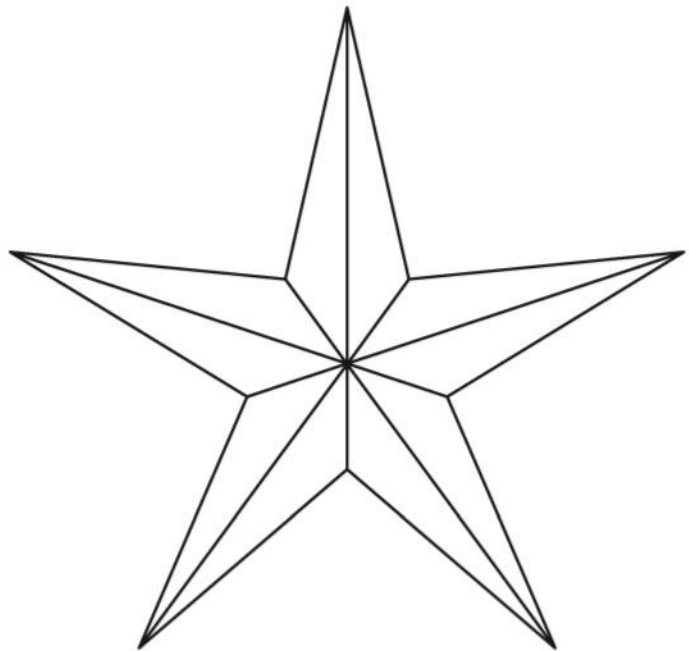
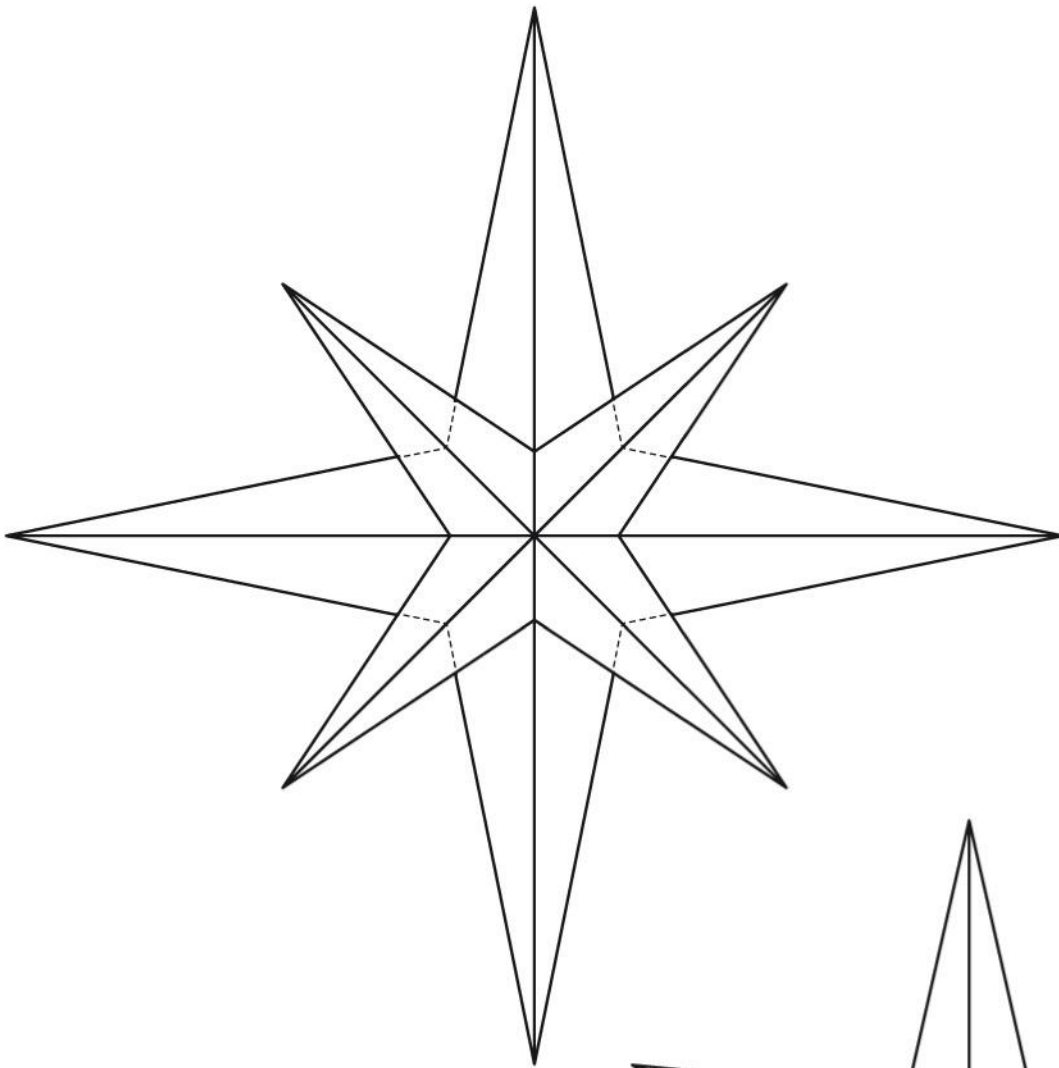

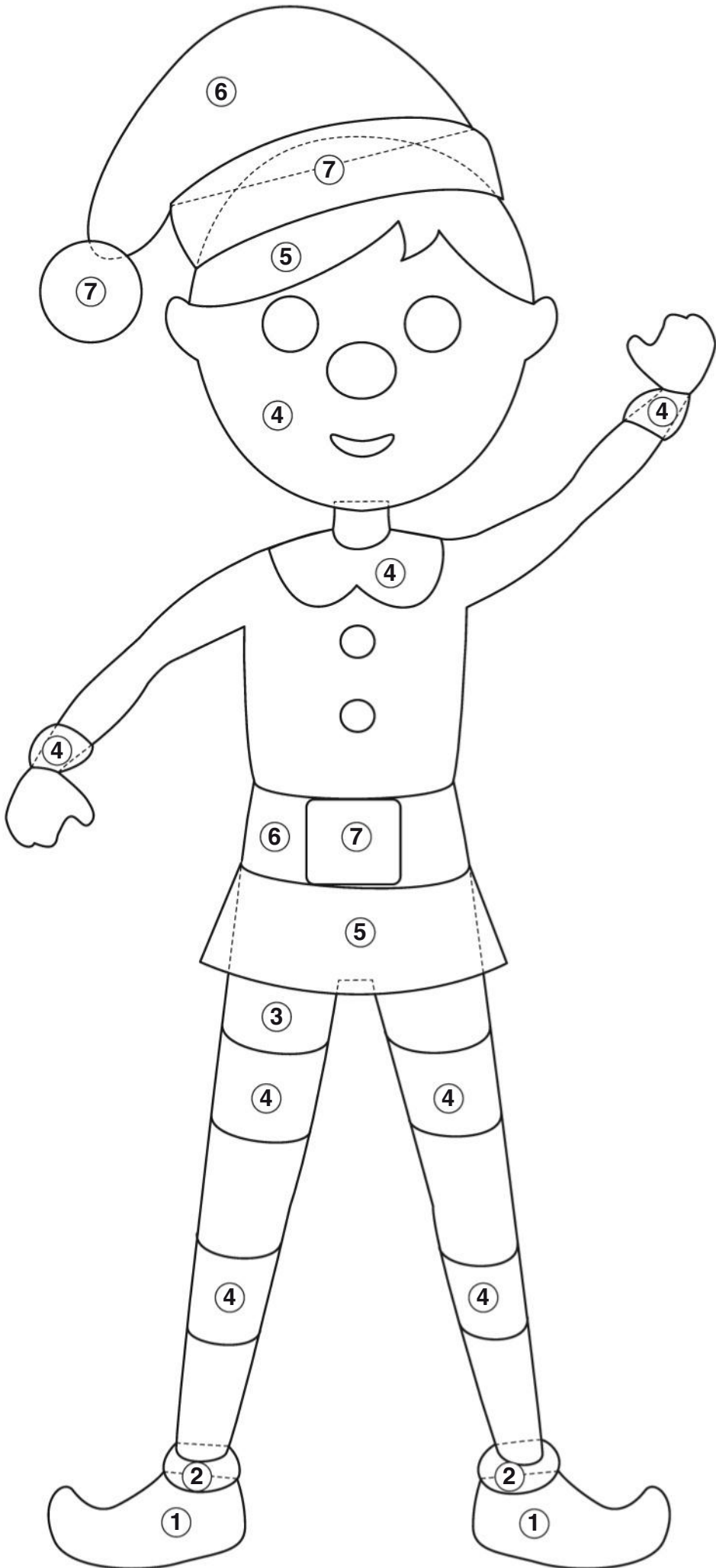

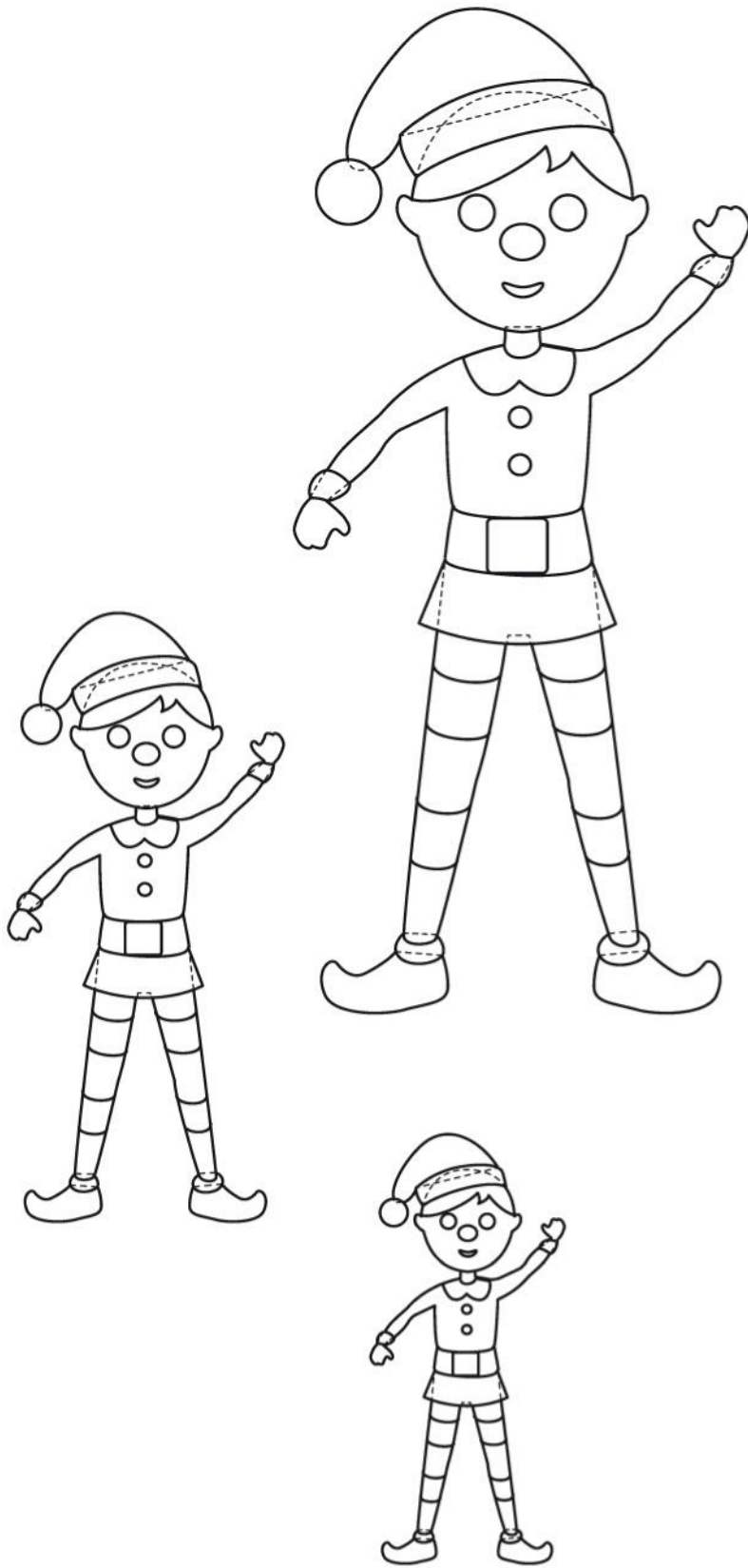

FIREPLACE

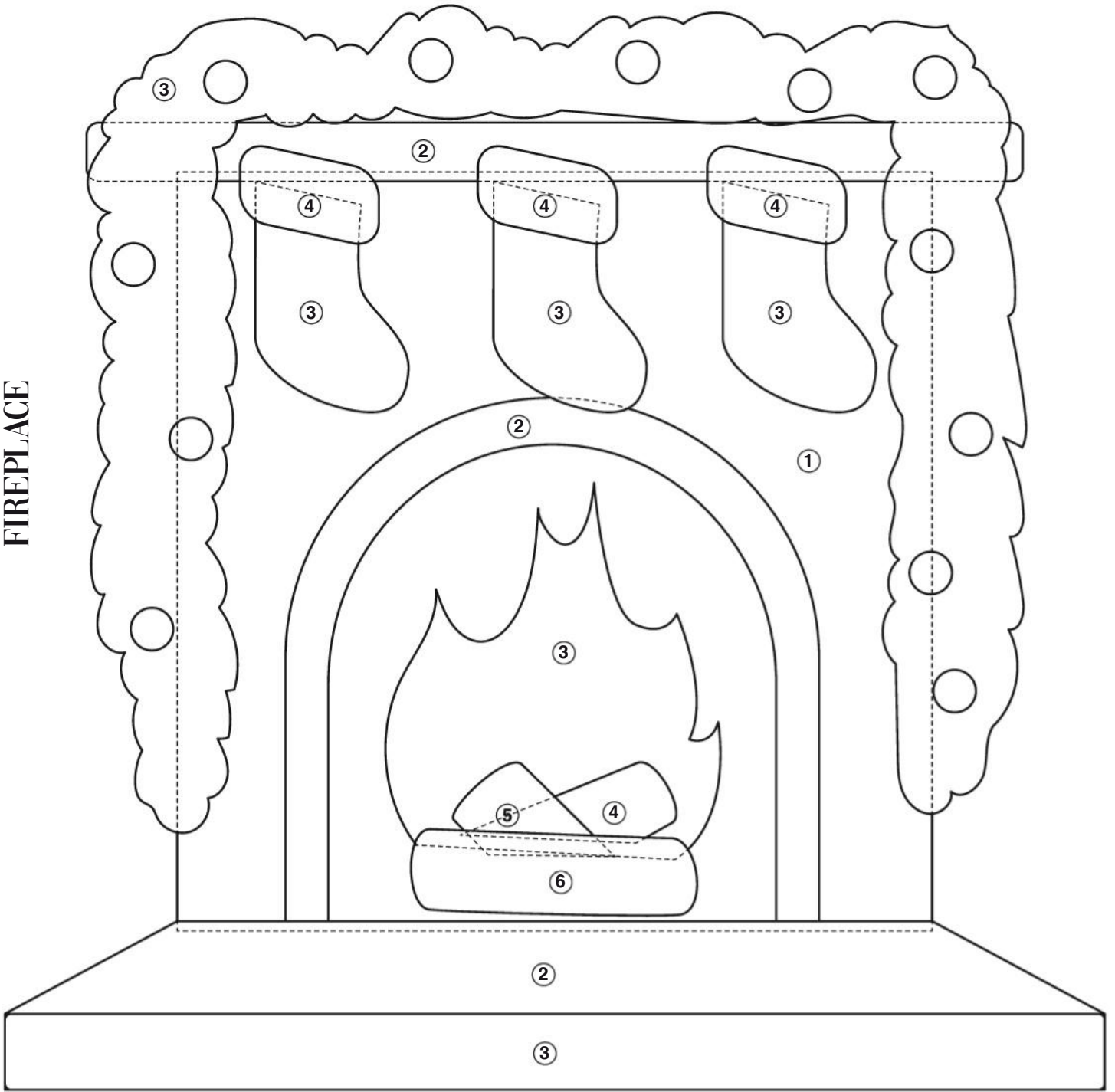

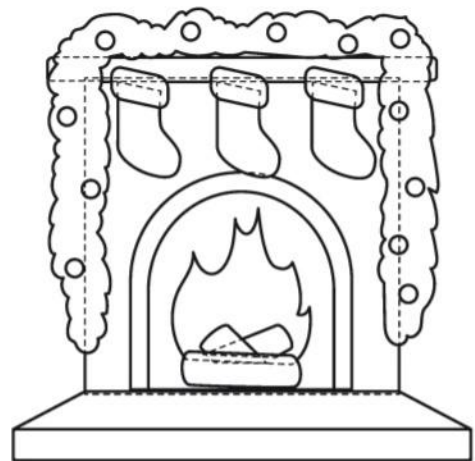
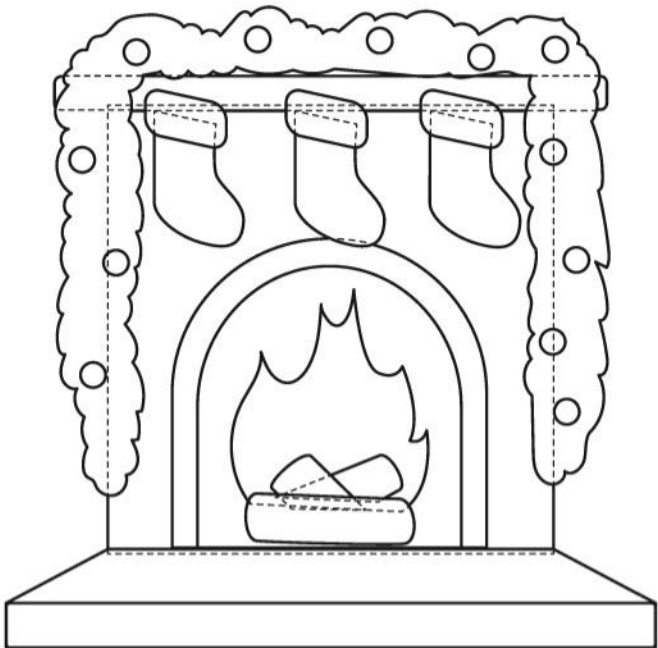
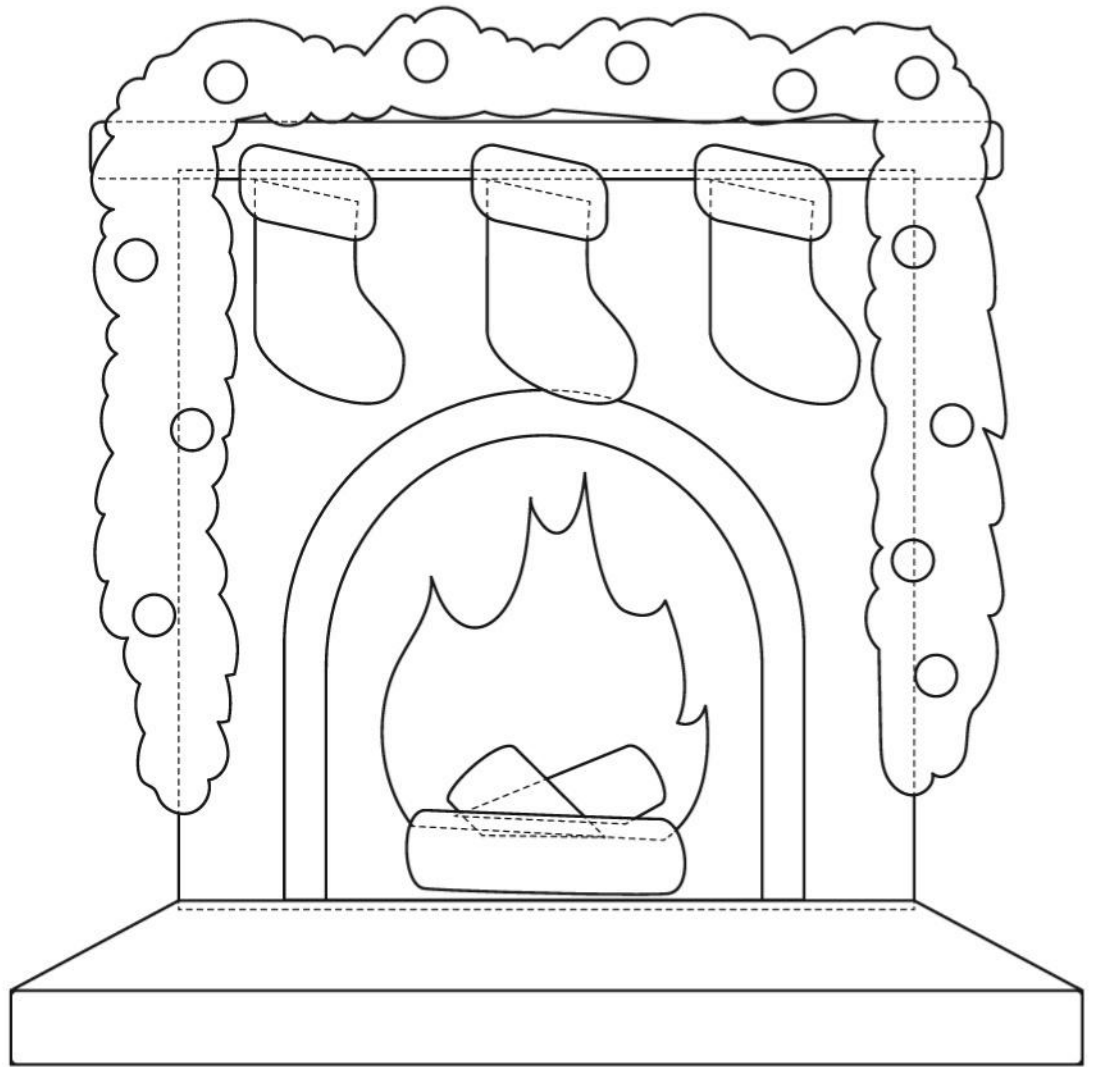

GINGERBREAD MAN

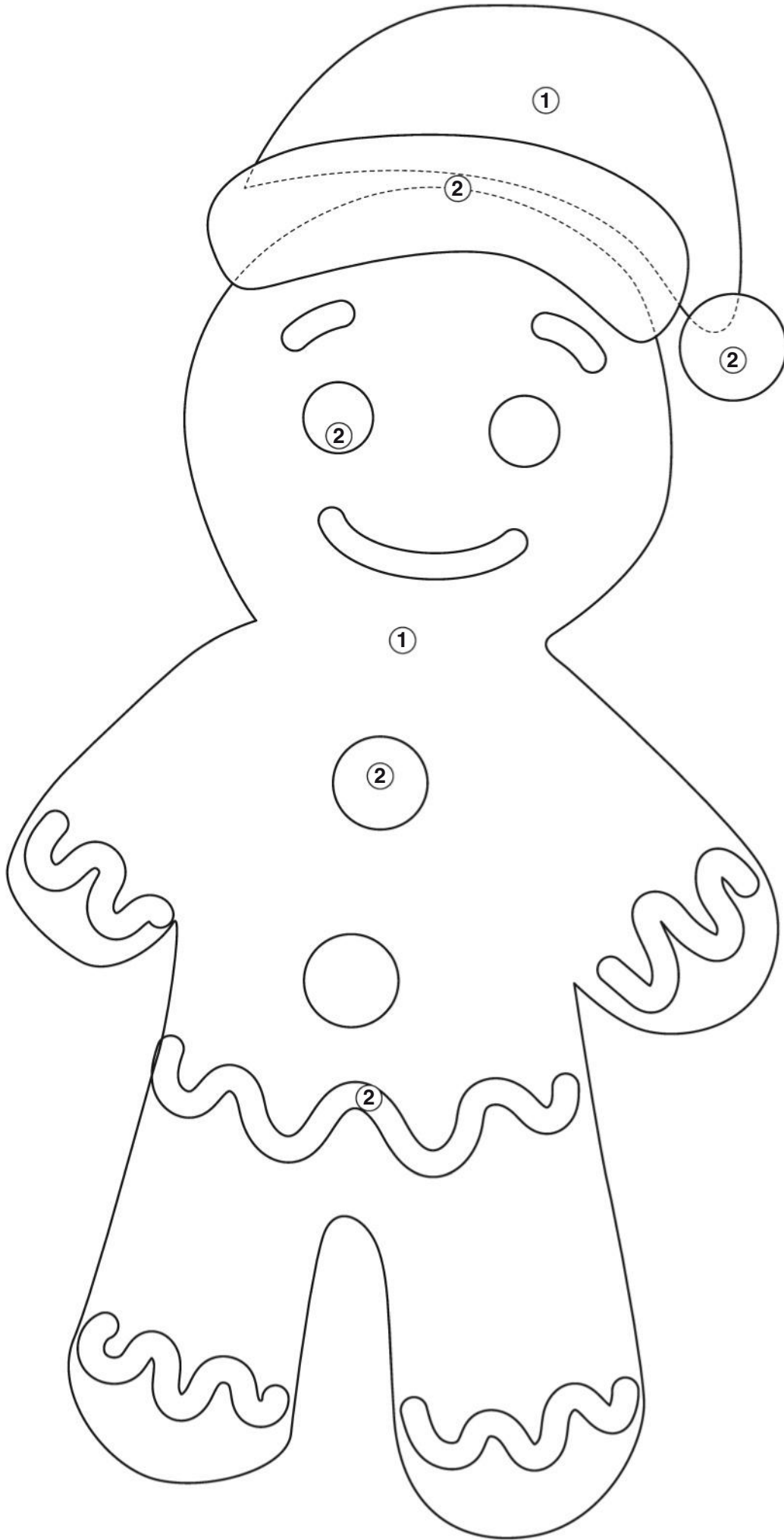

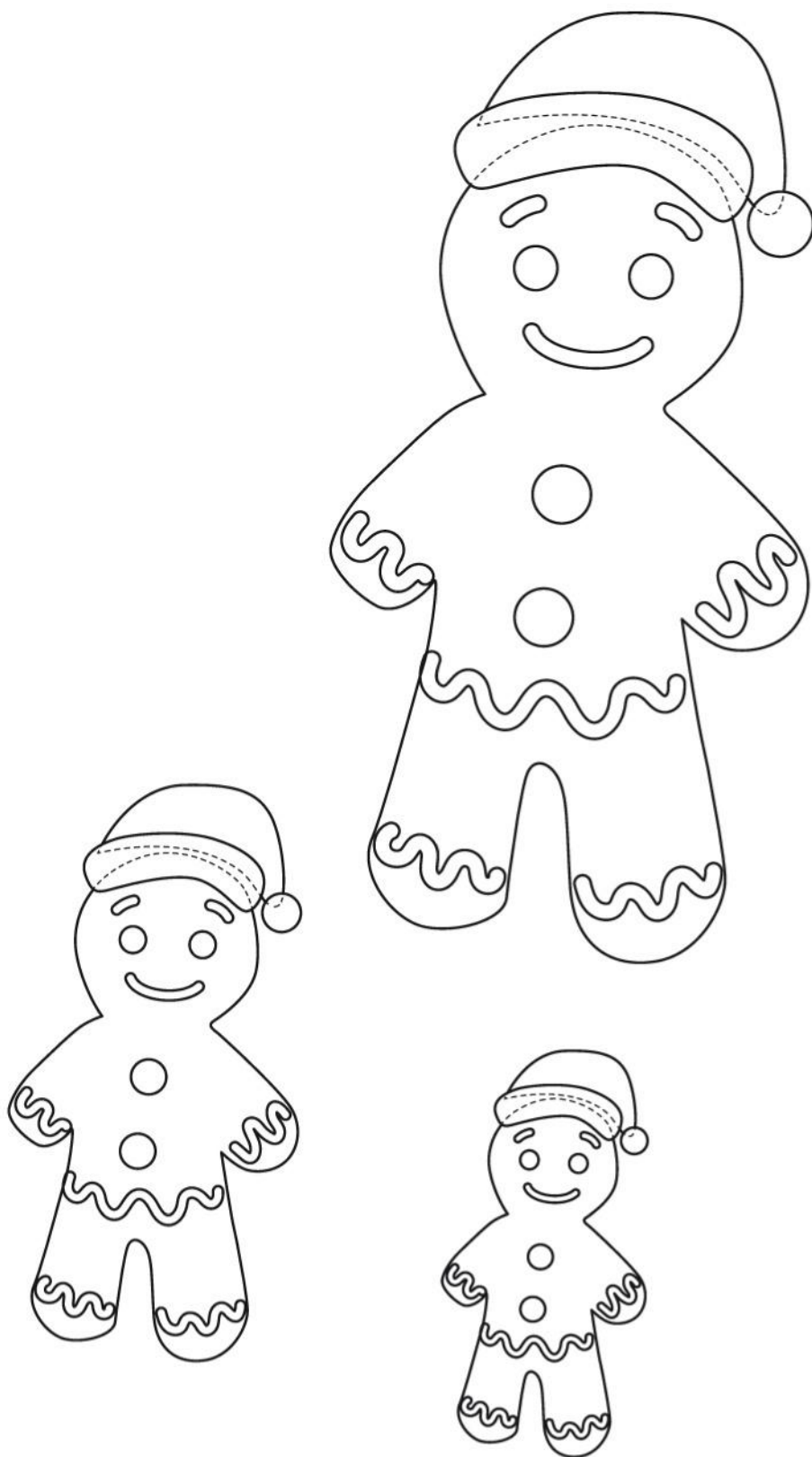

GONK

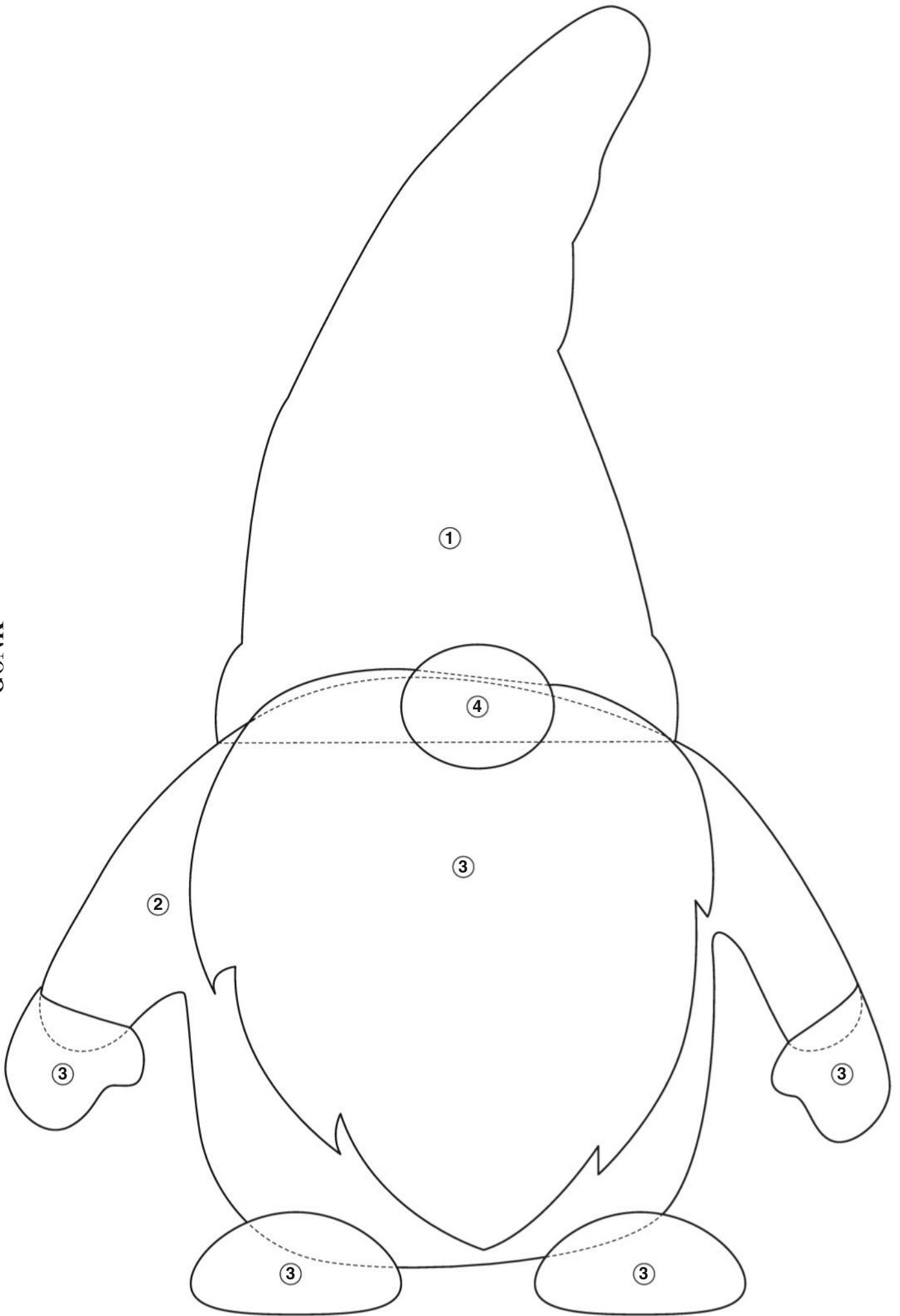

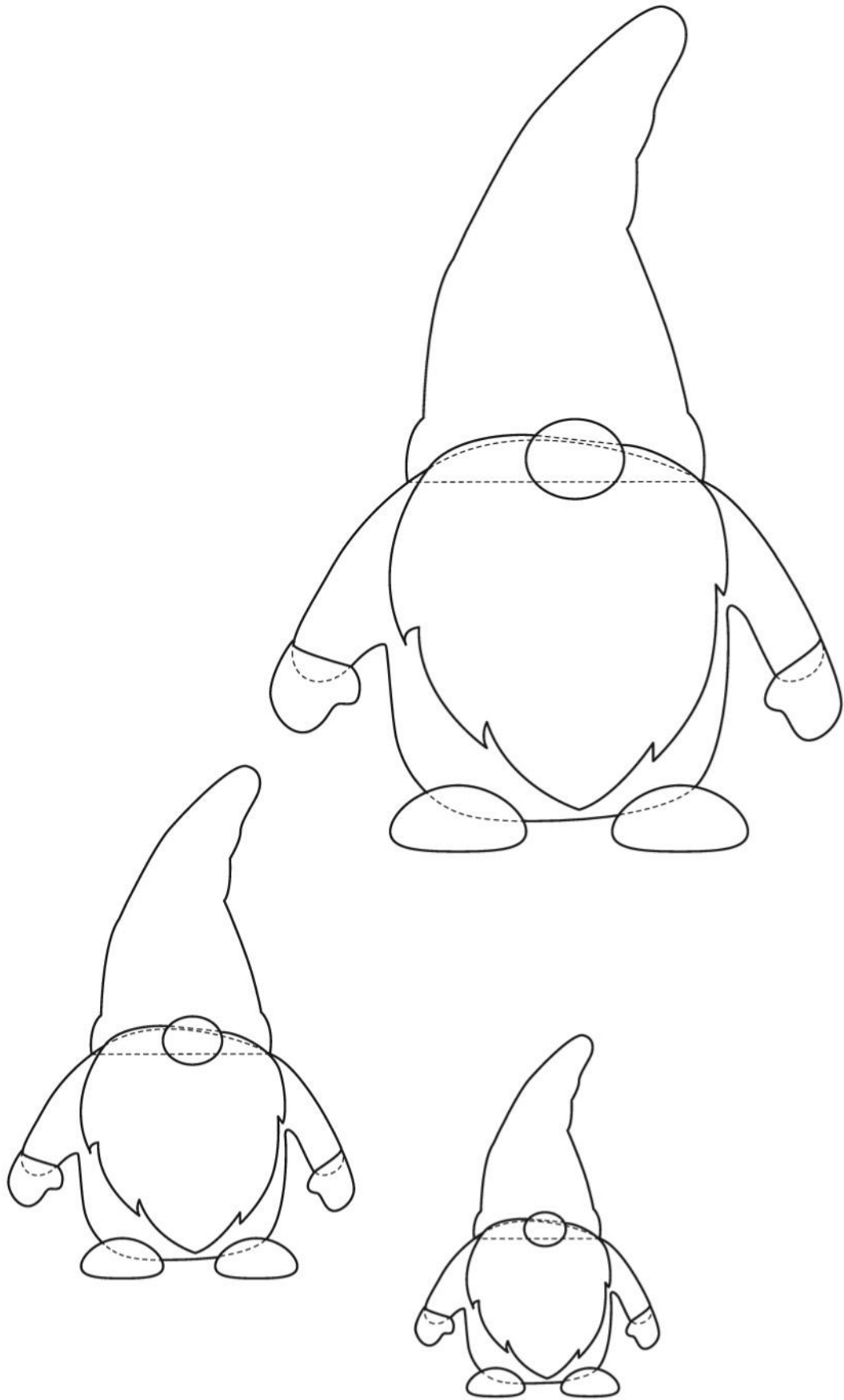

HOT CHOCOALTE

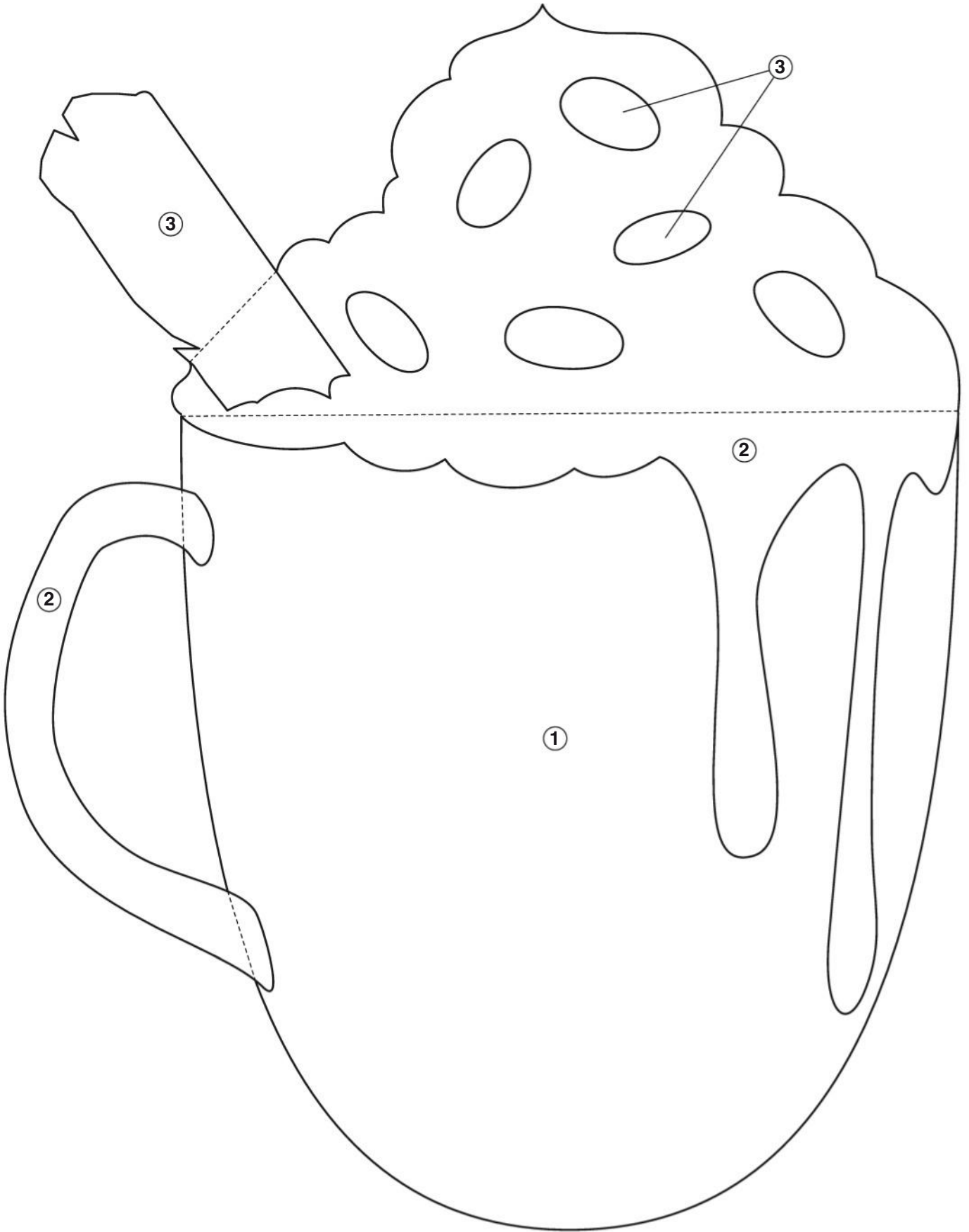



LANTERN

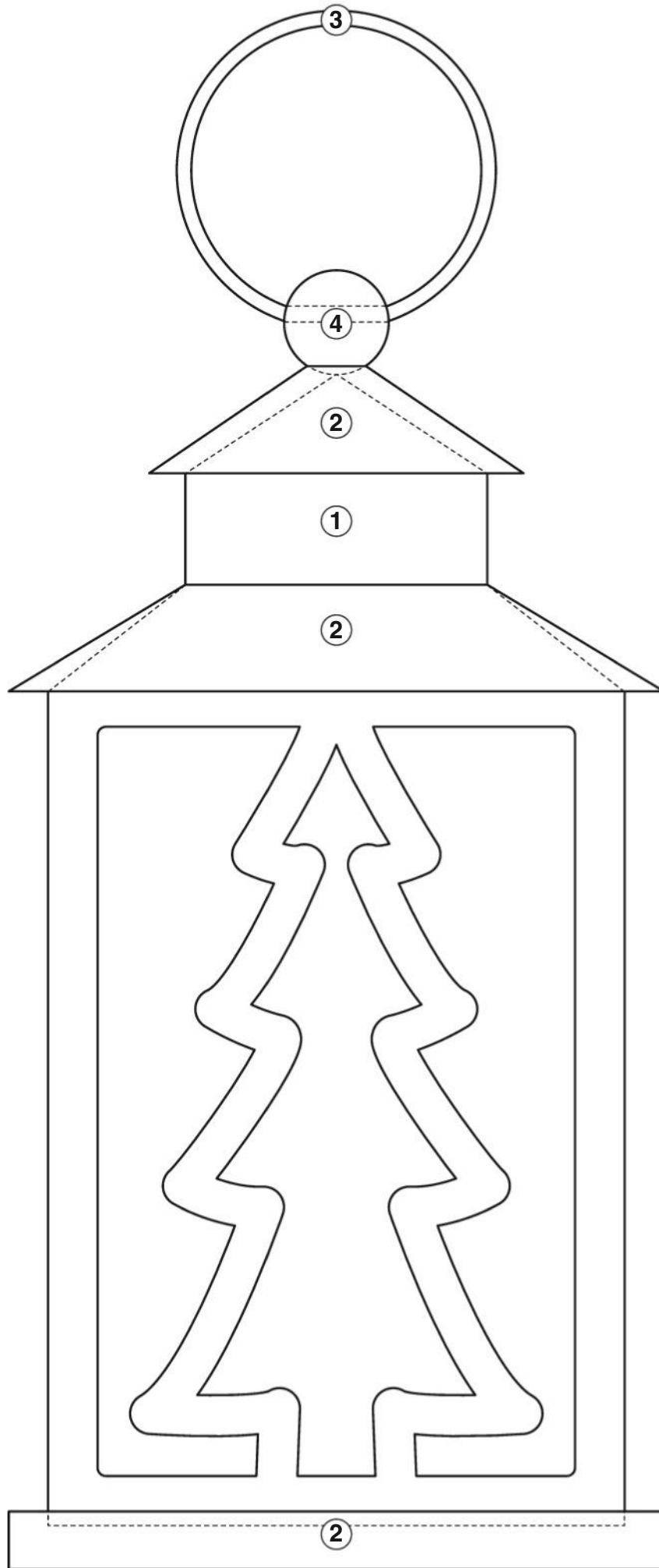

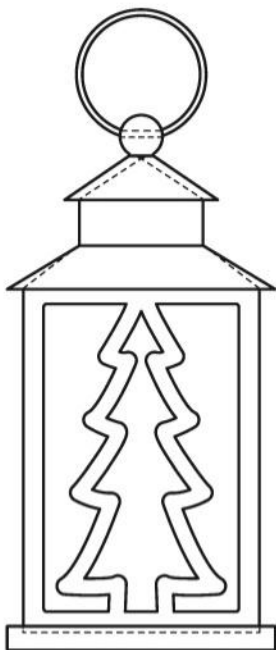
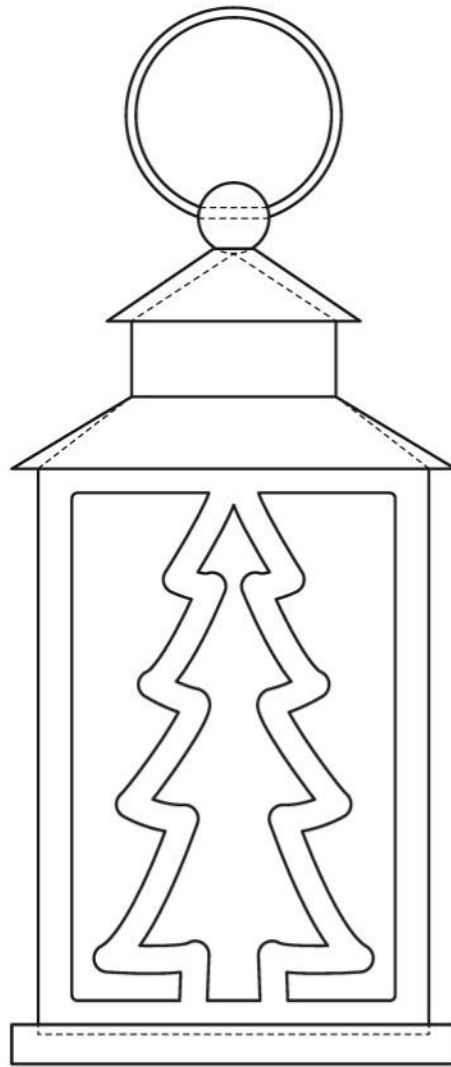

MILK CARROTS

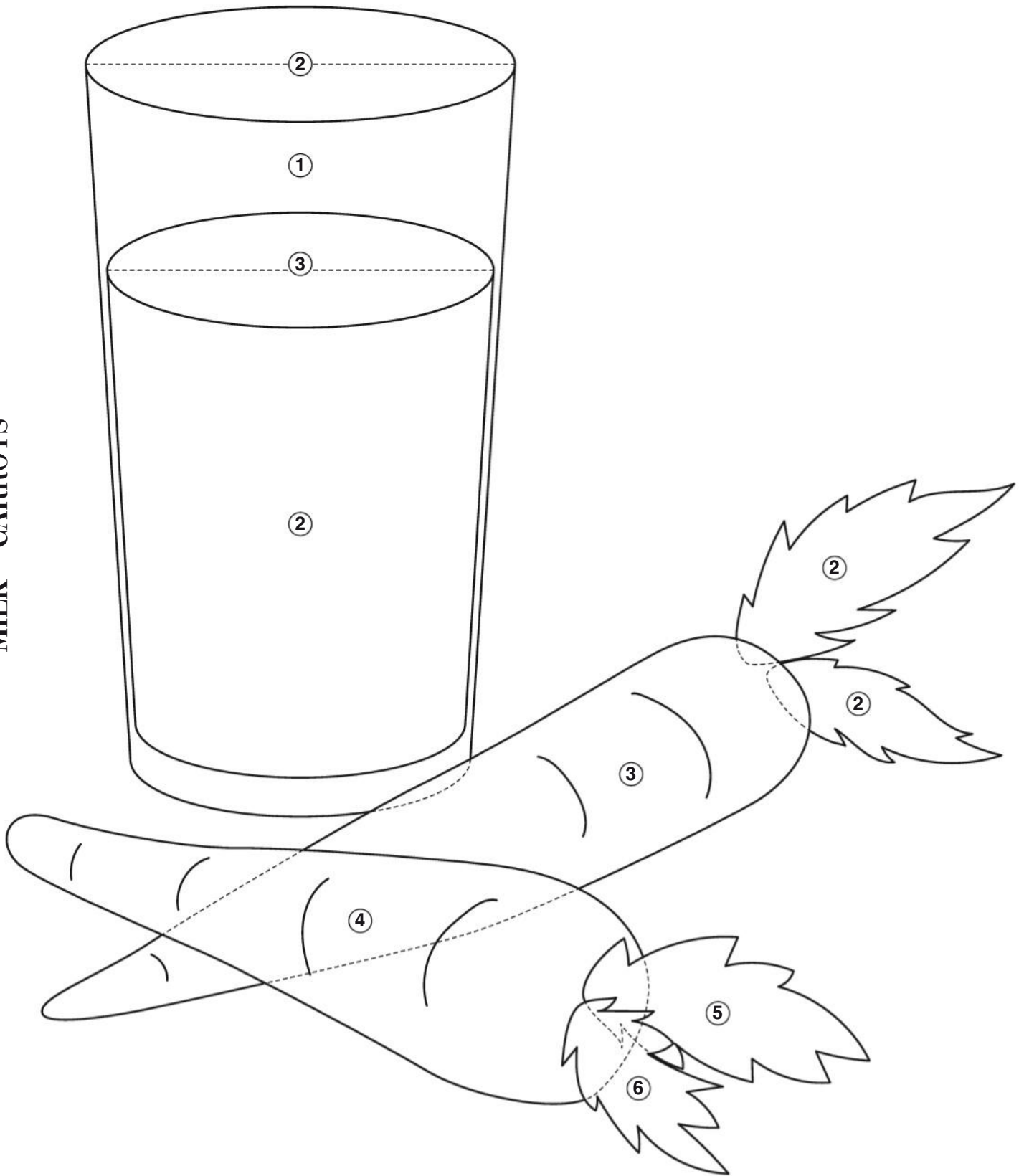

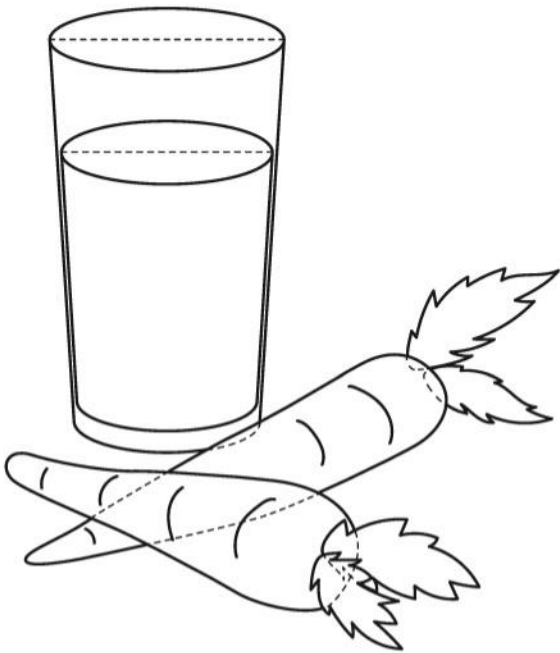
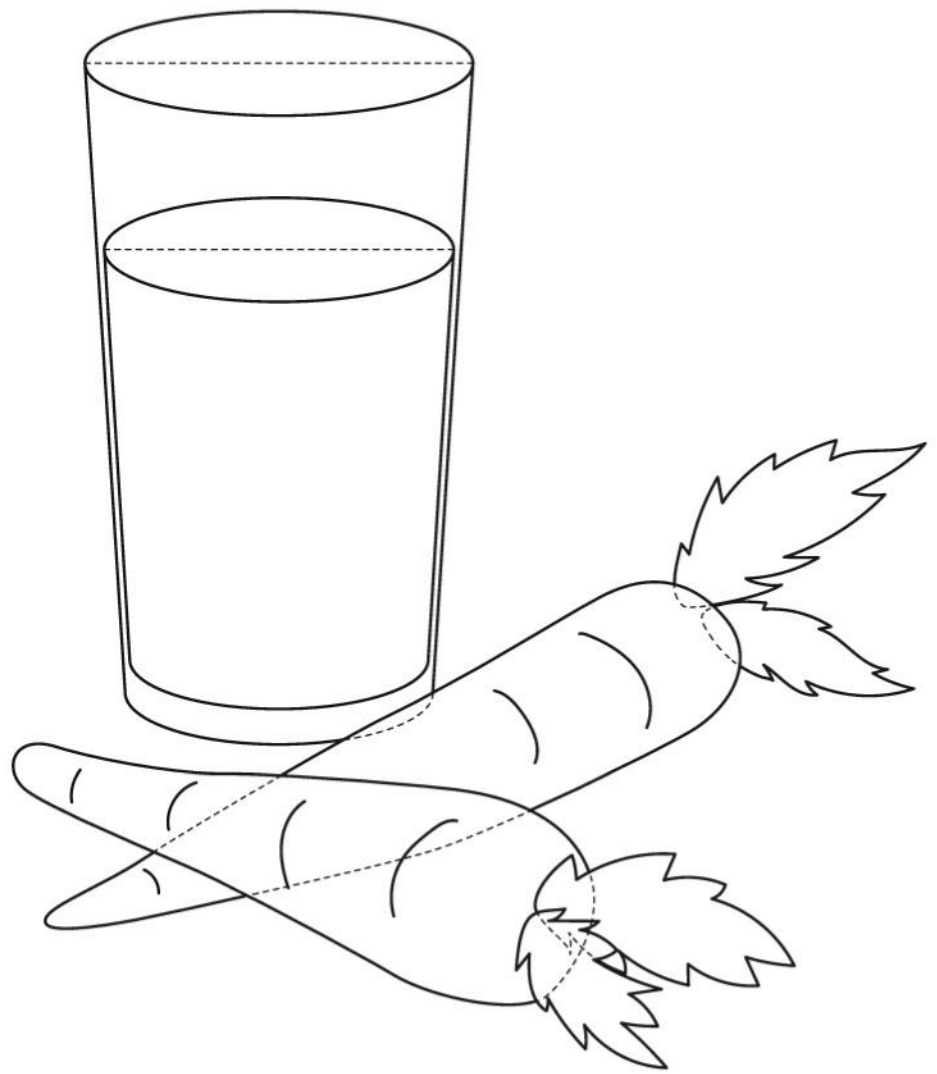

WALRUS

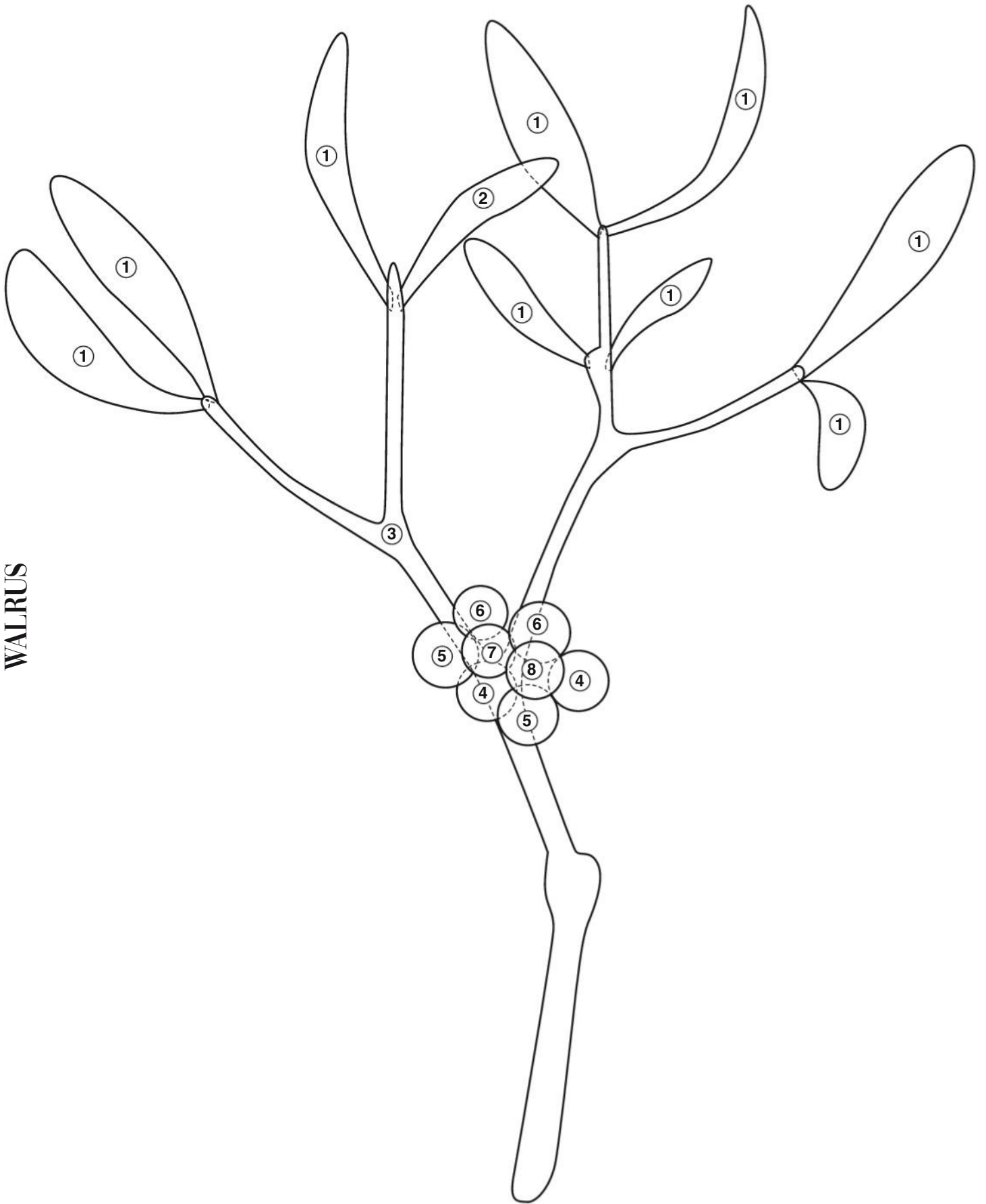

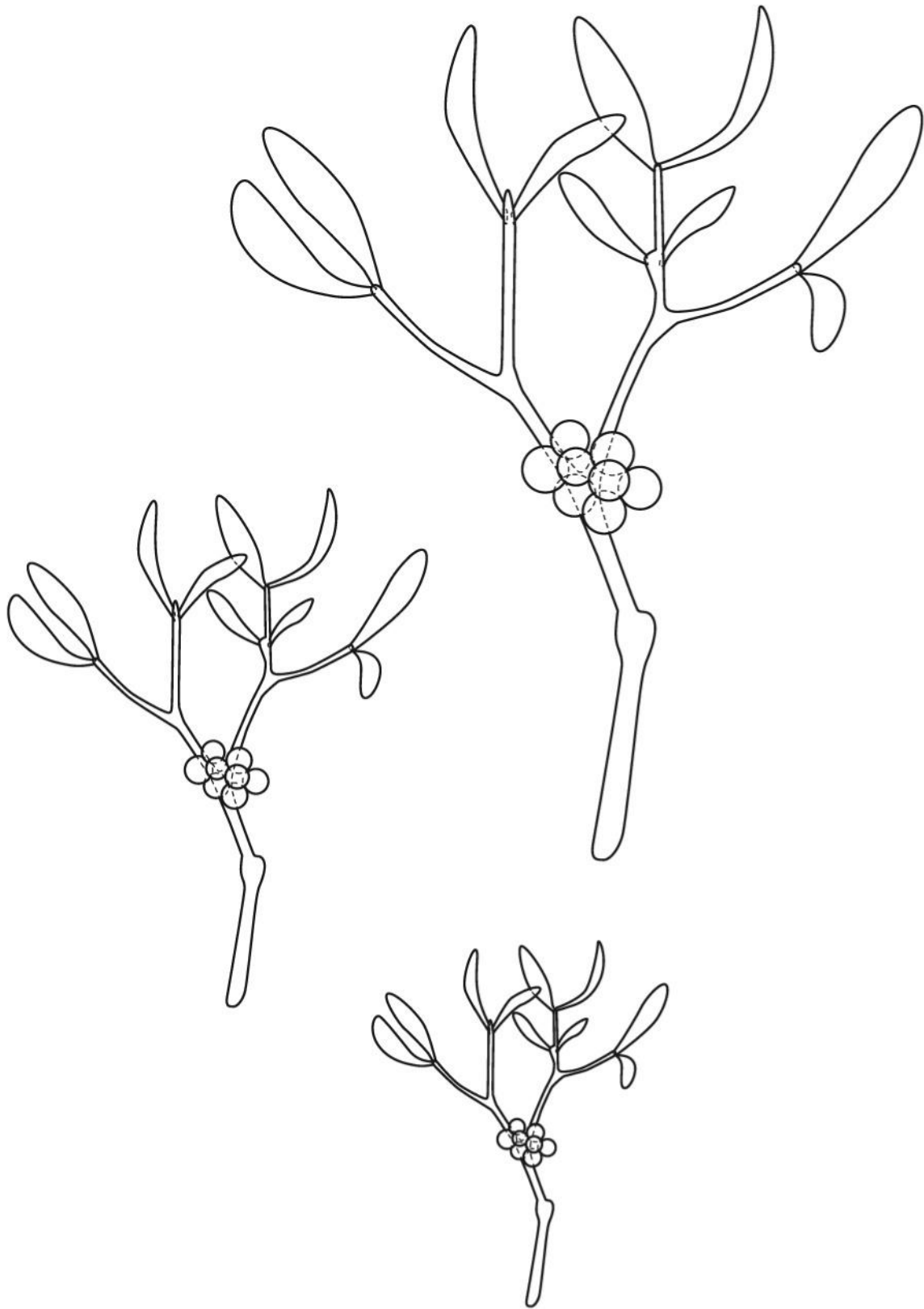

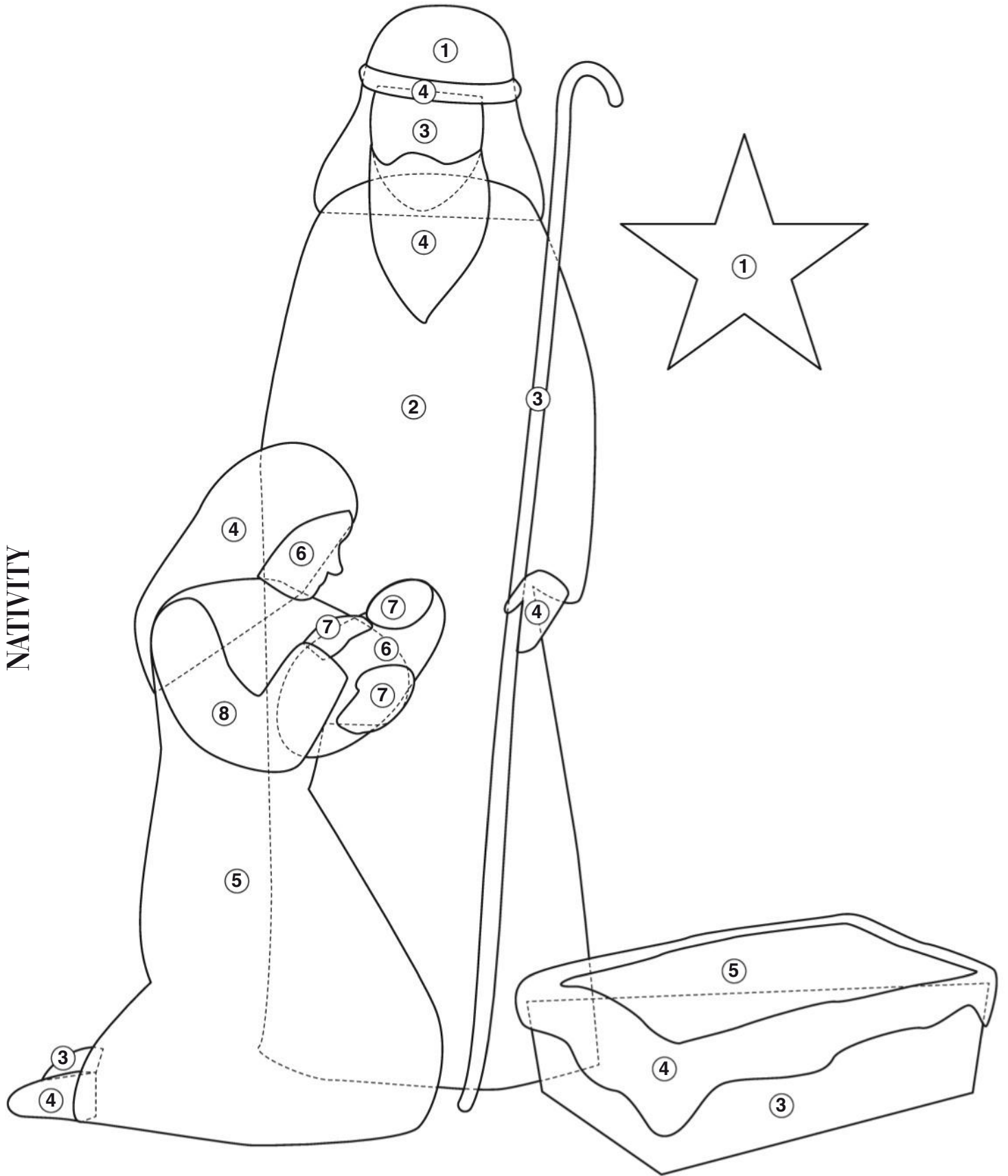

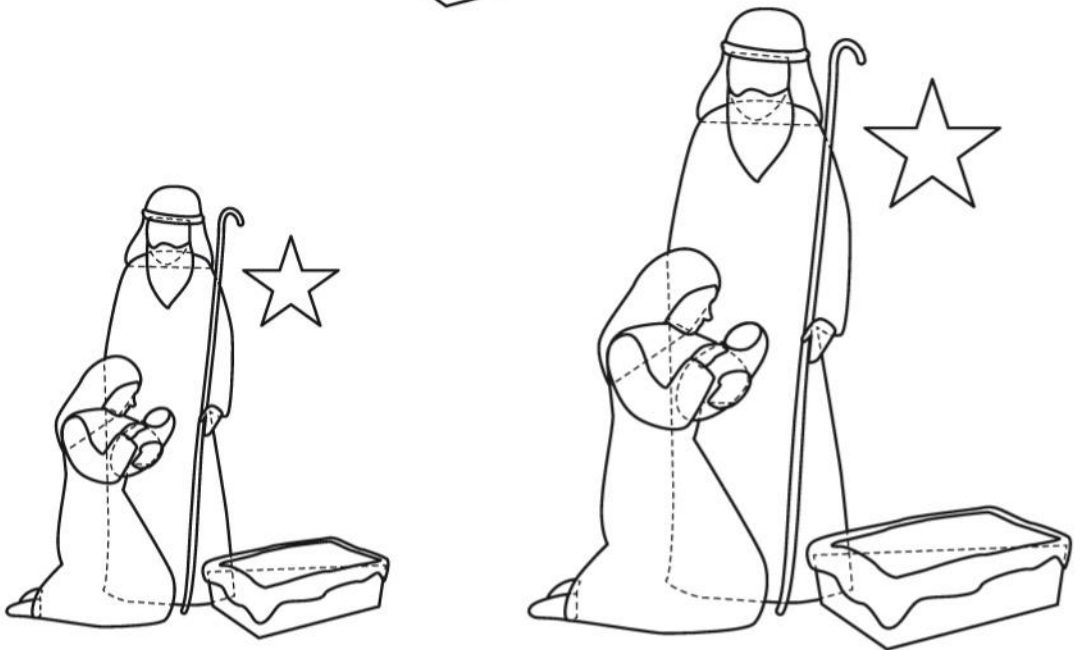

NUTCRACKER

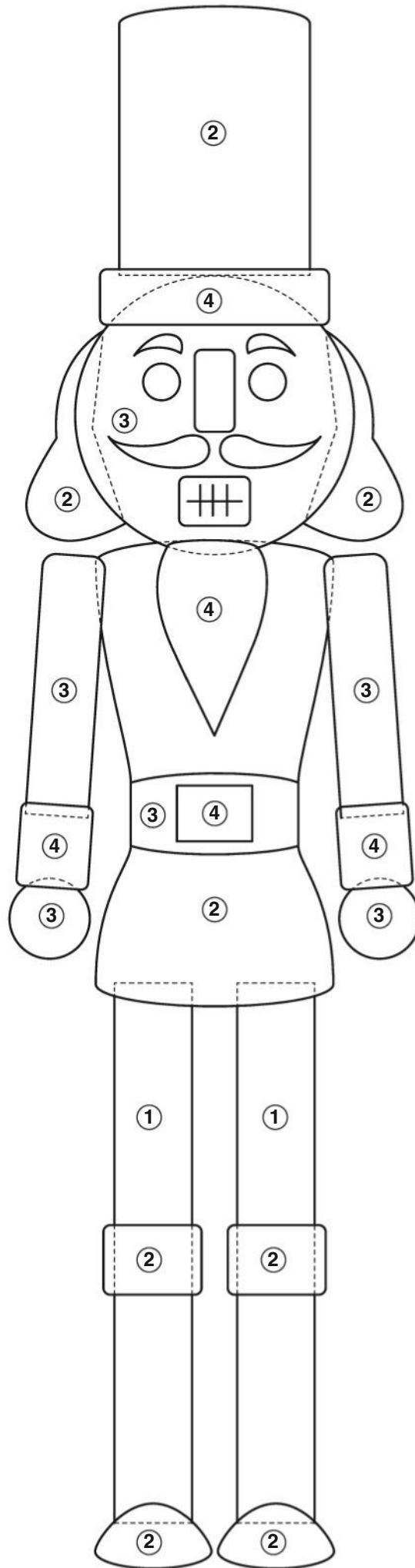

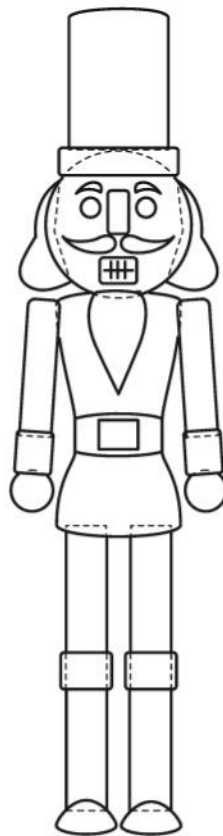
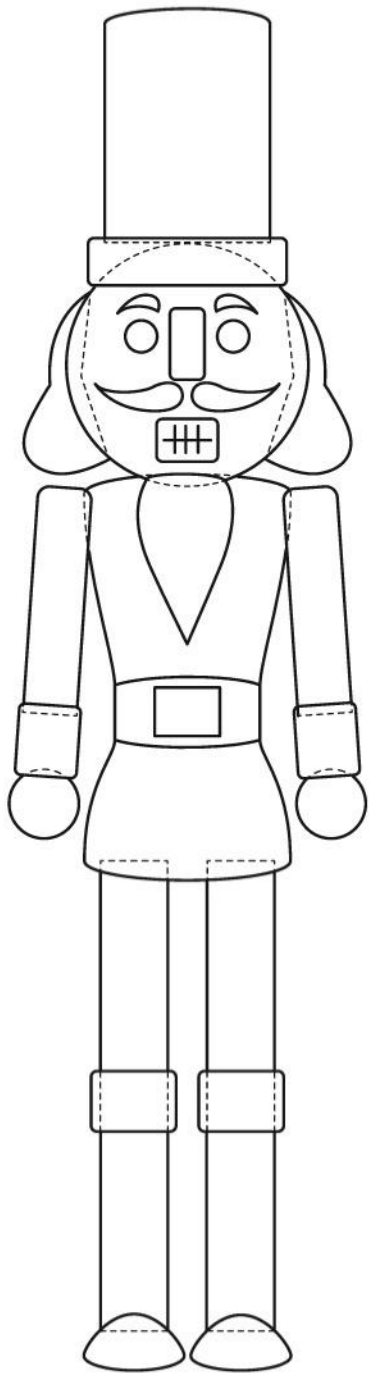

RUDDOLPH

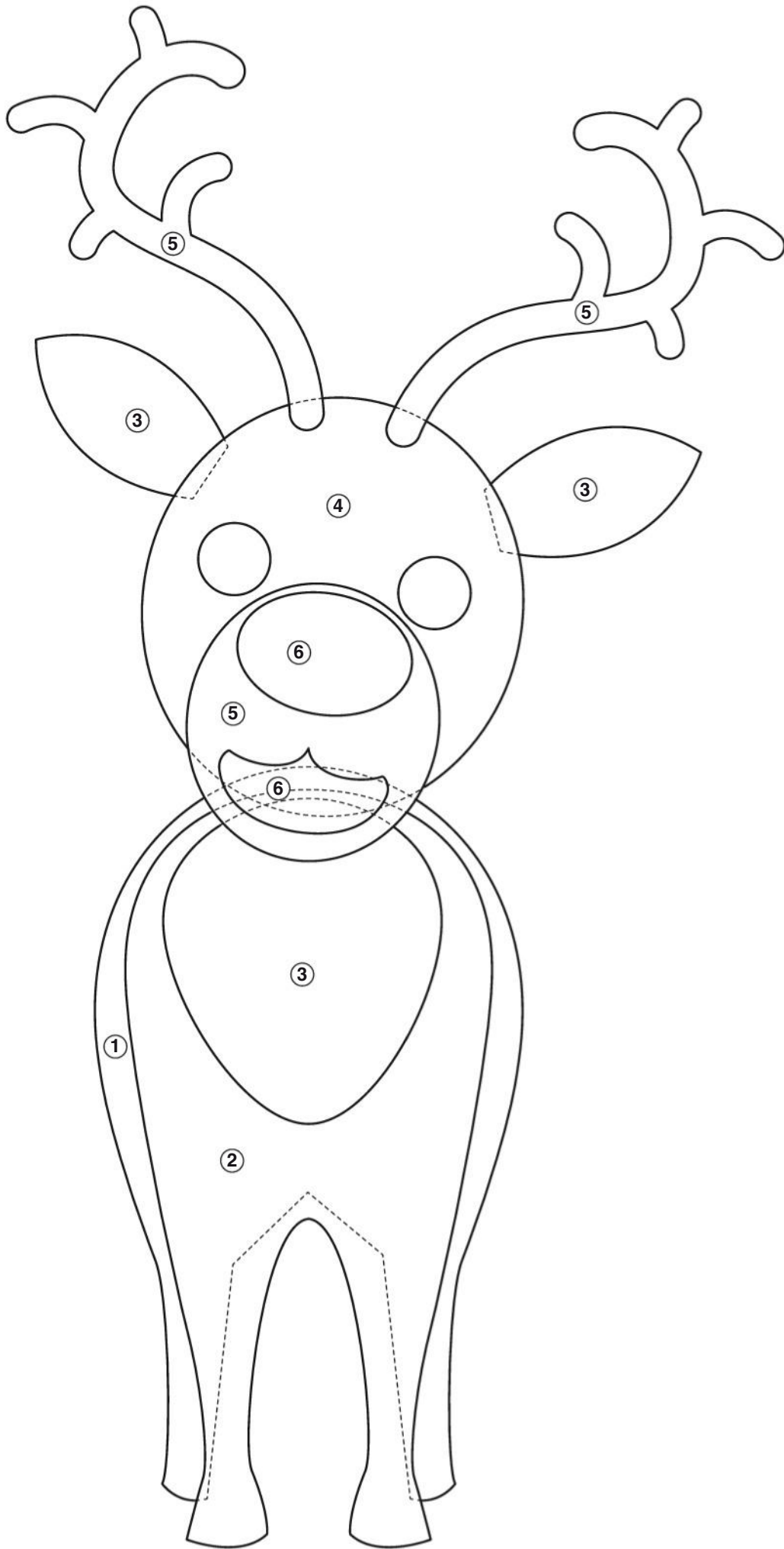

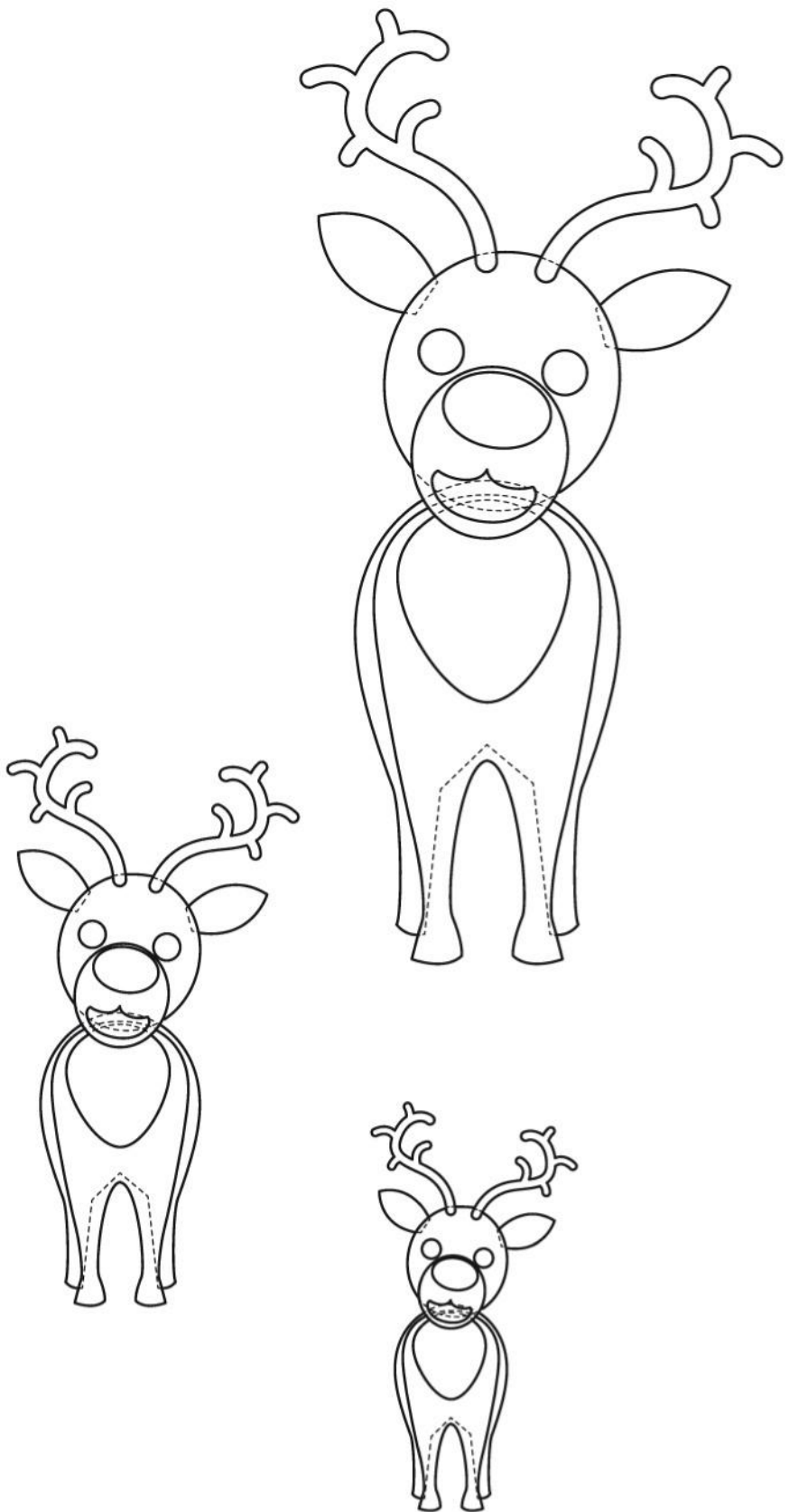

ORNAGE

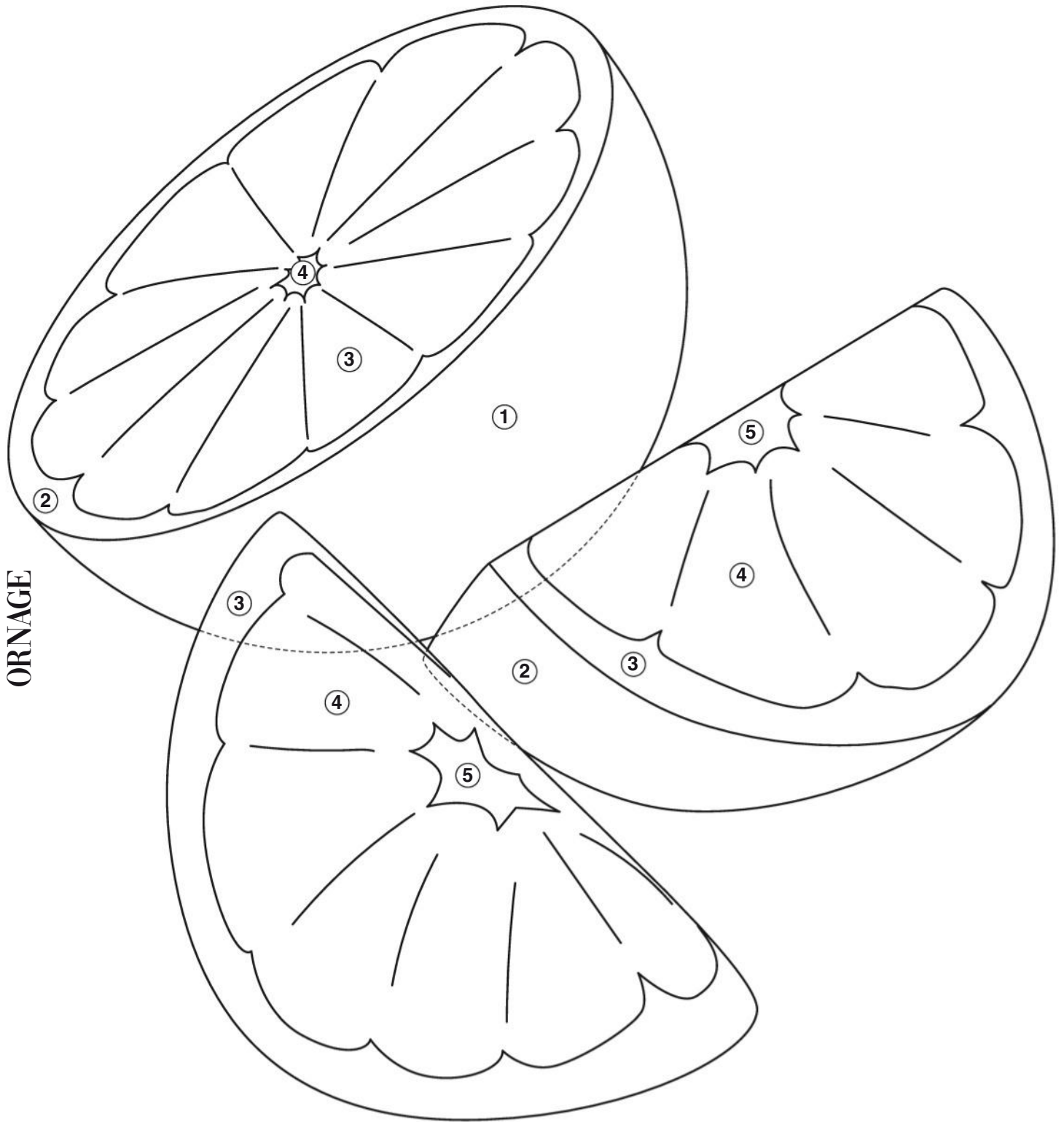

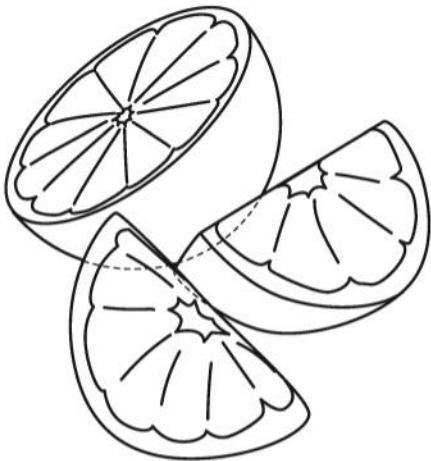
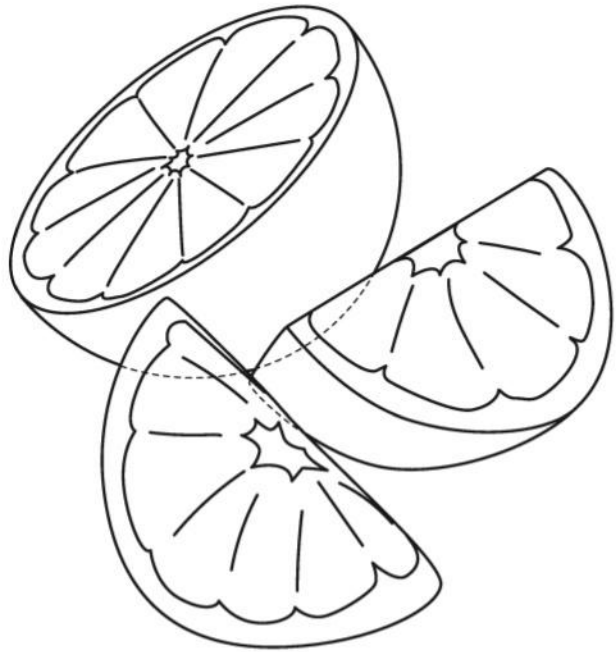
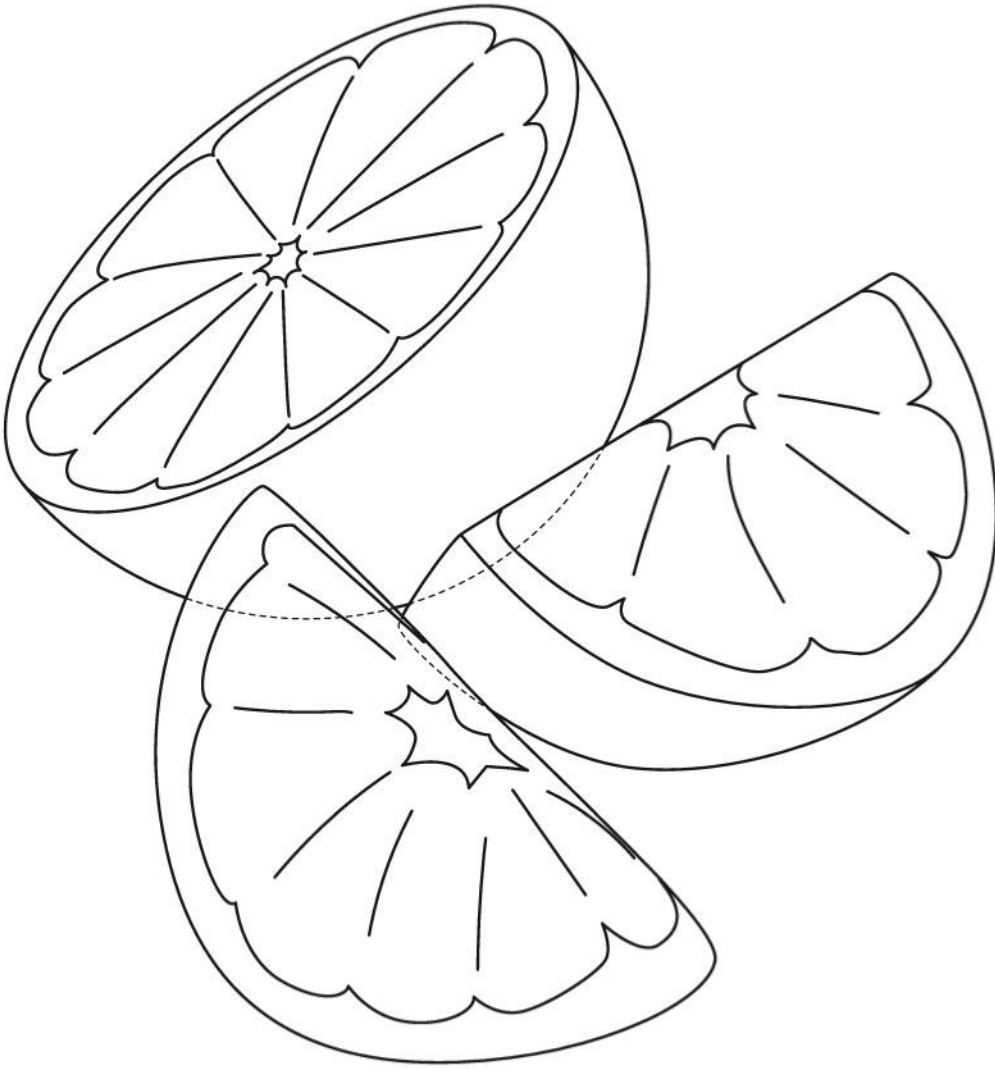

PINECONE

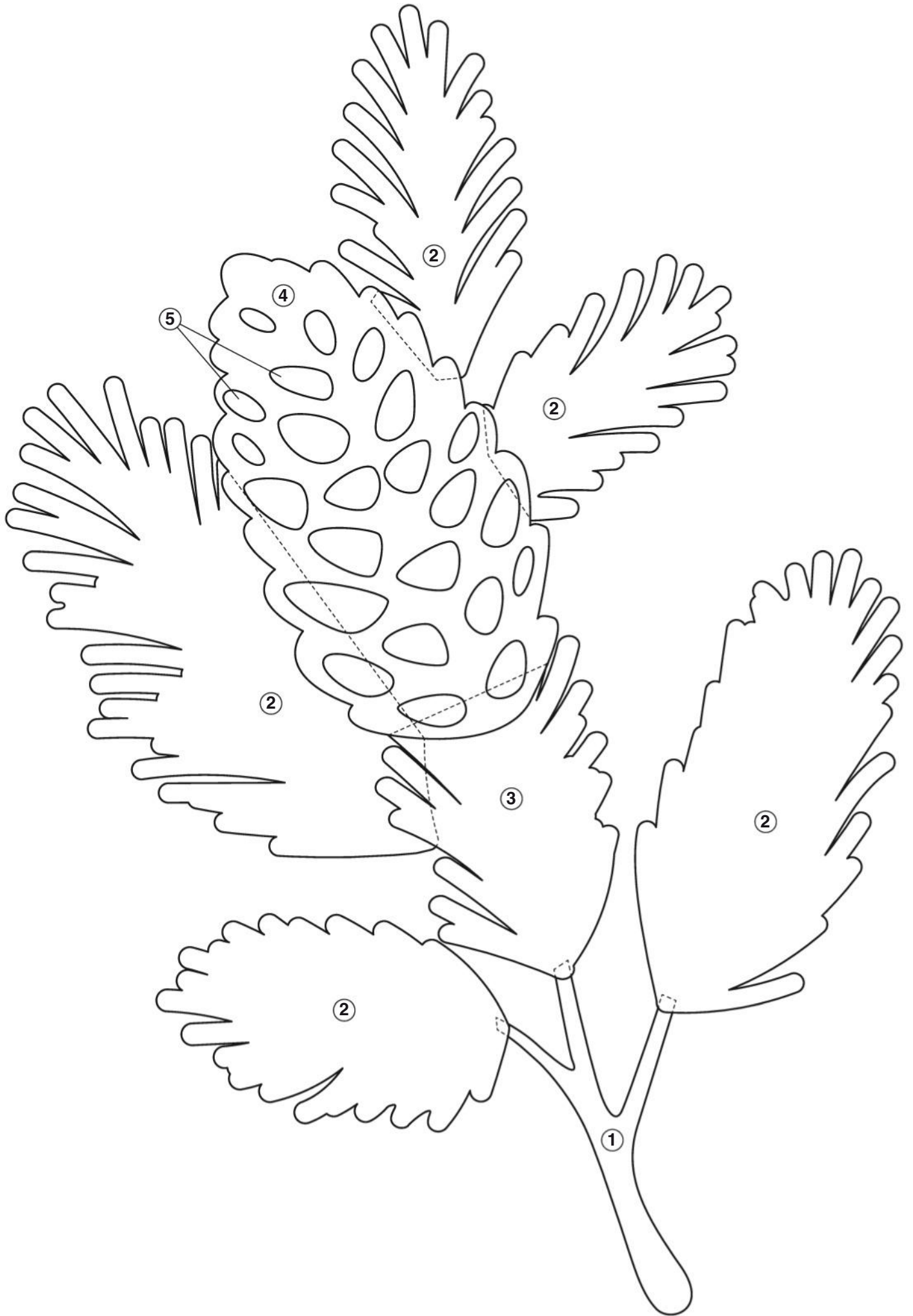



POINSETTA

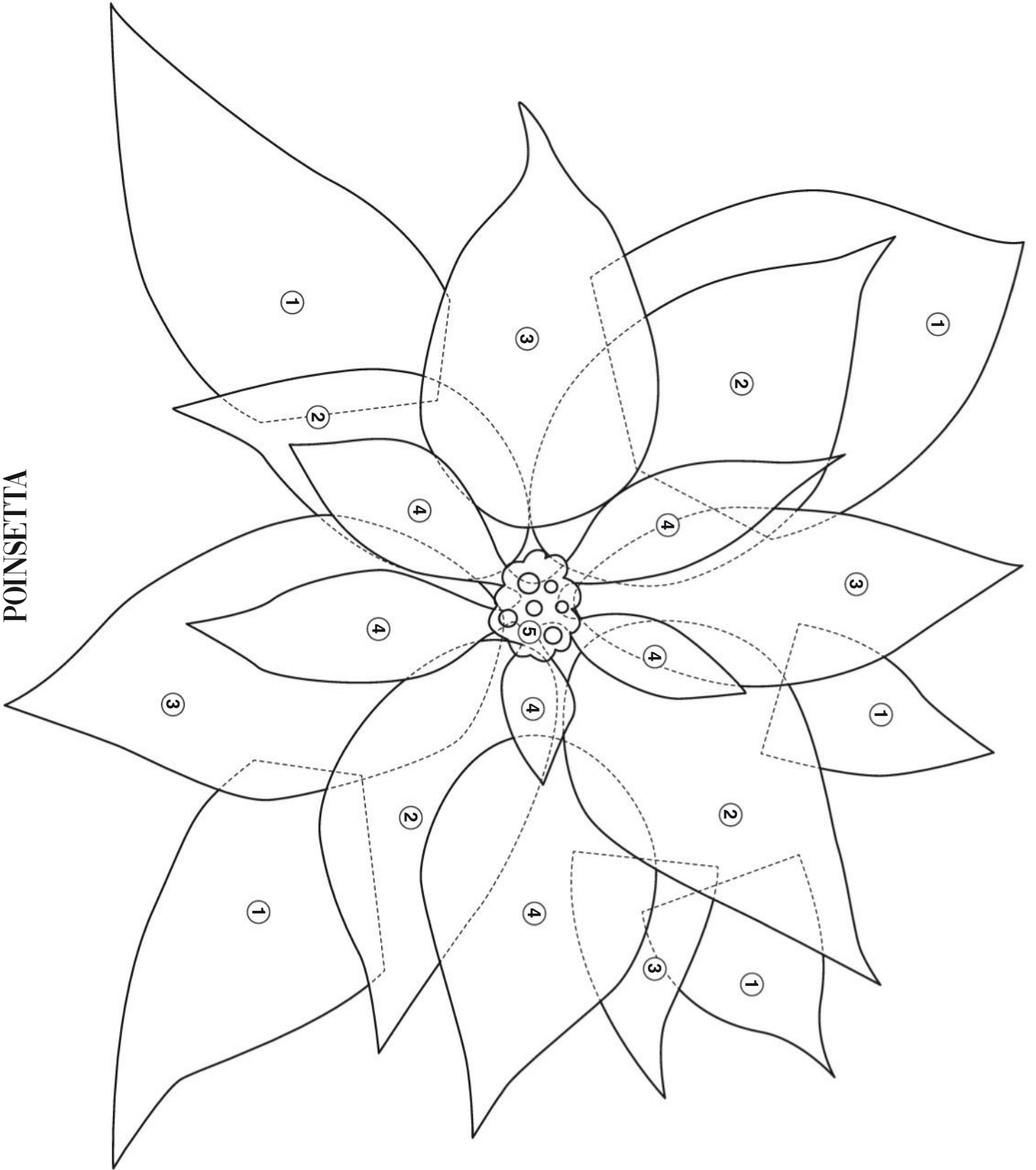

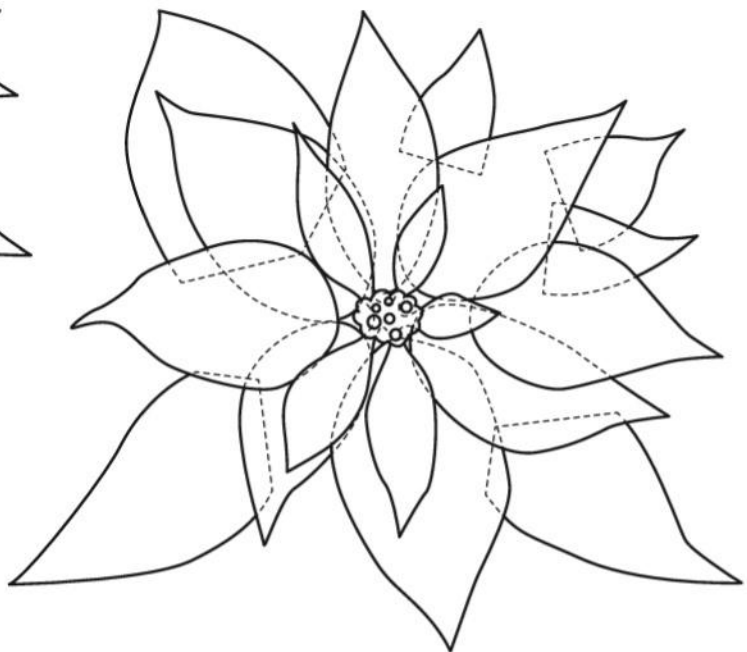
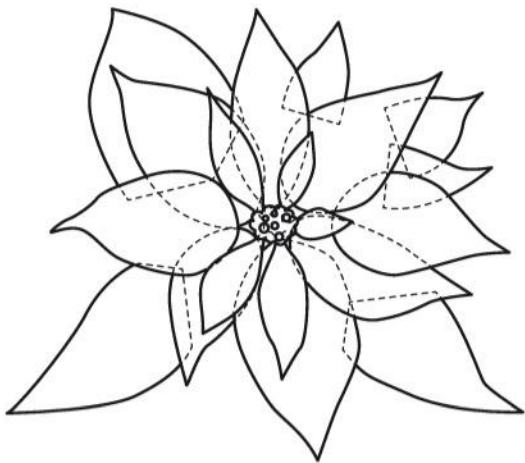
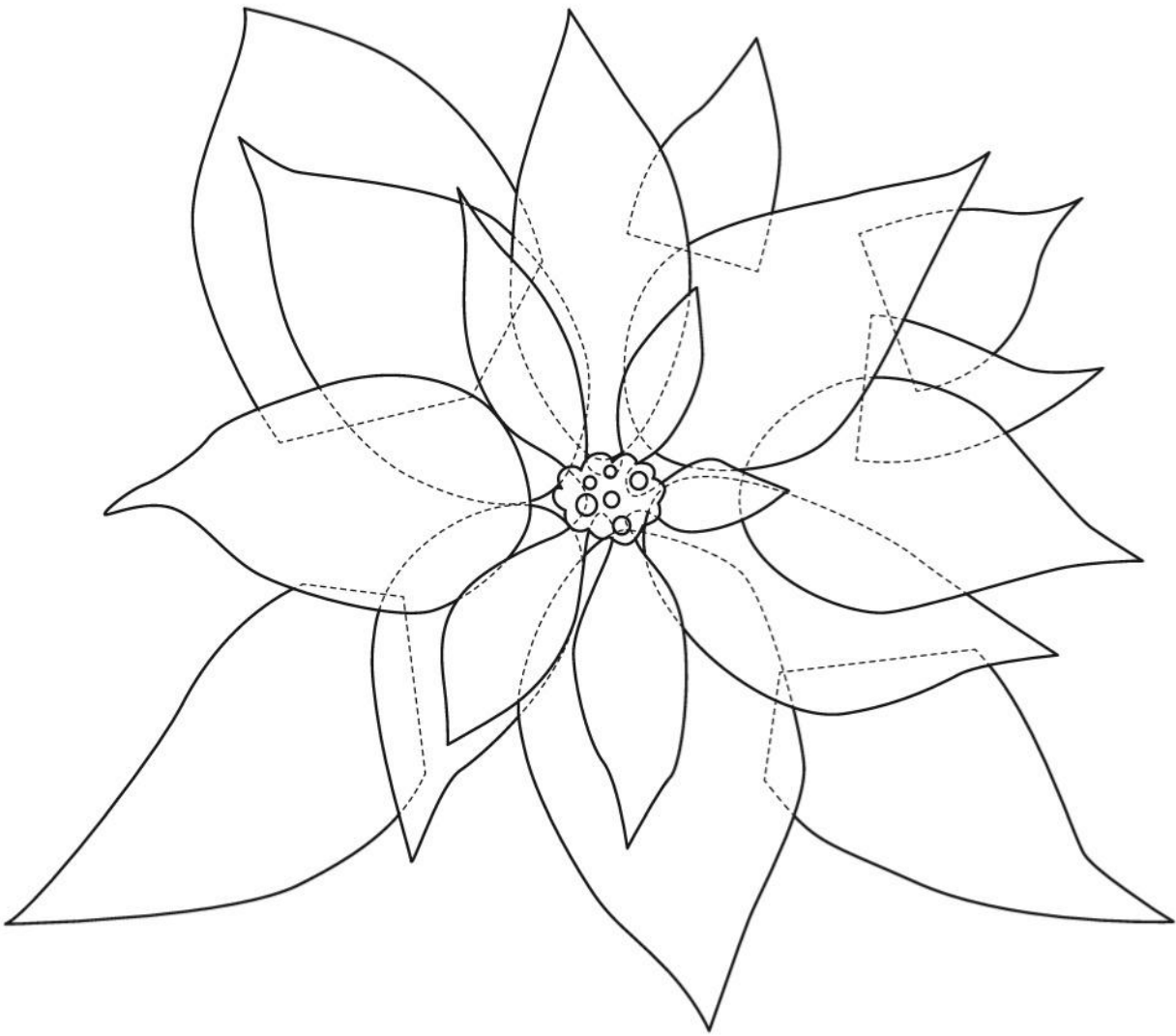

PRESENT

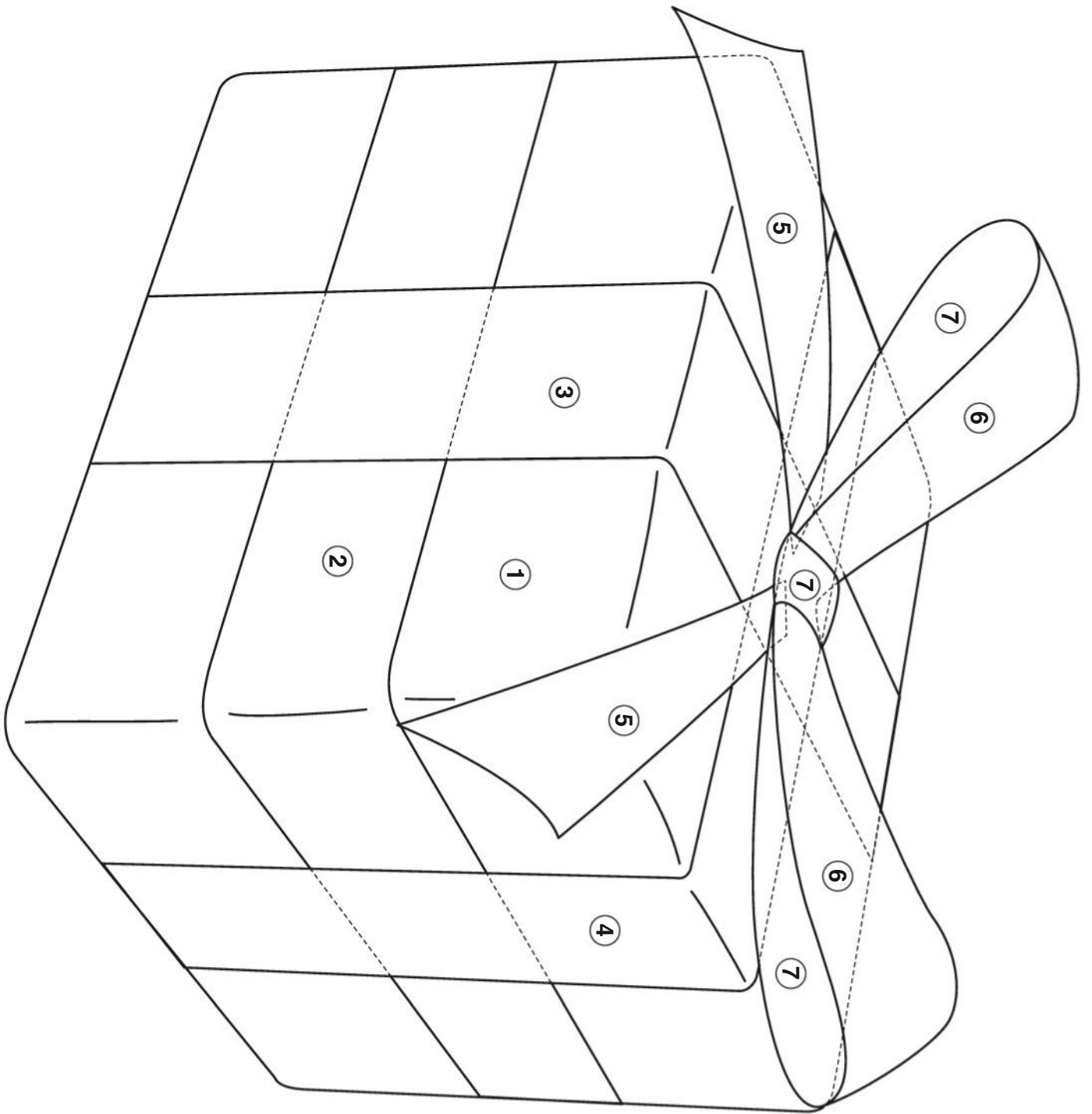



FATHER CHRISTMAS

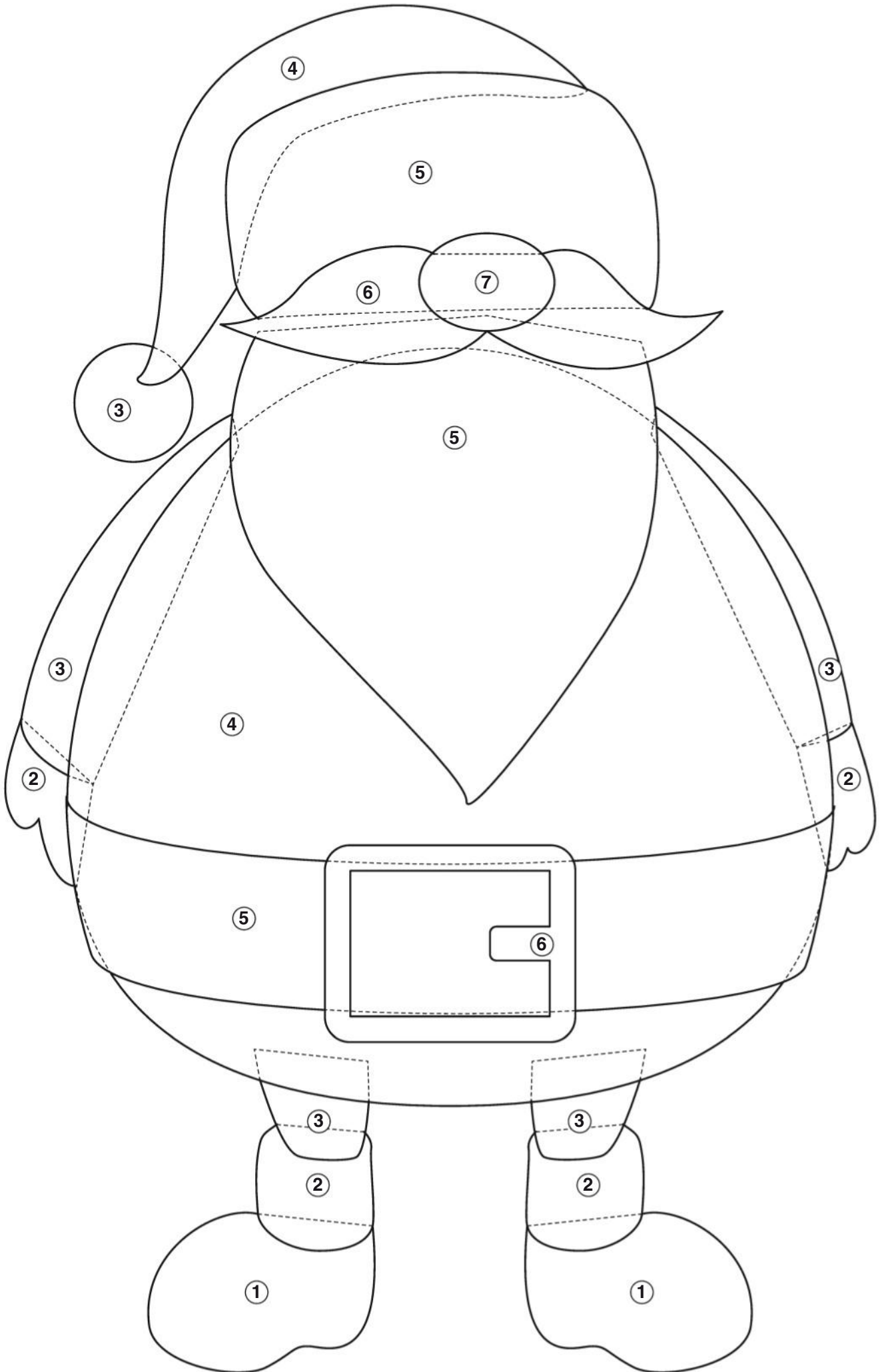

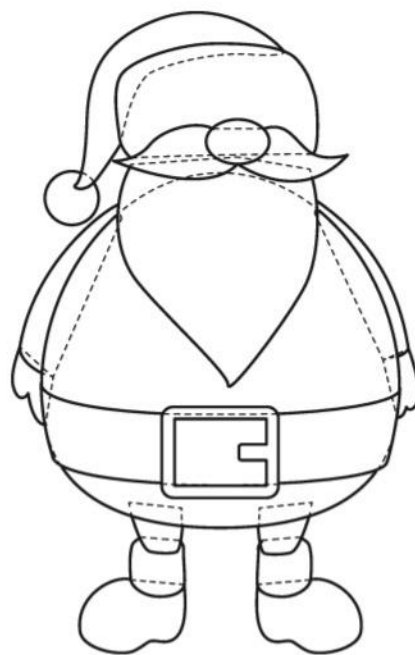
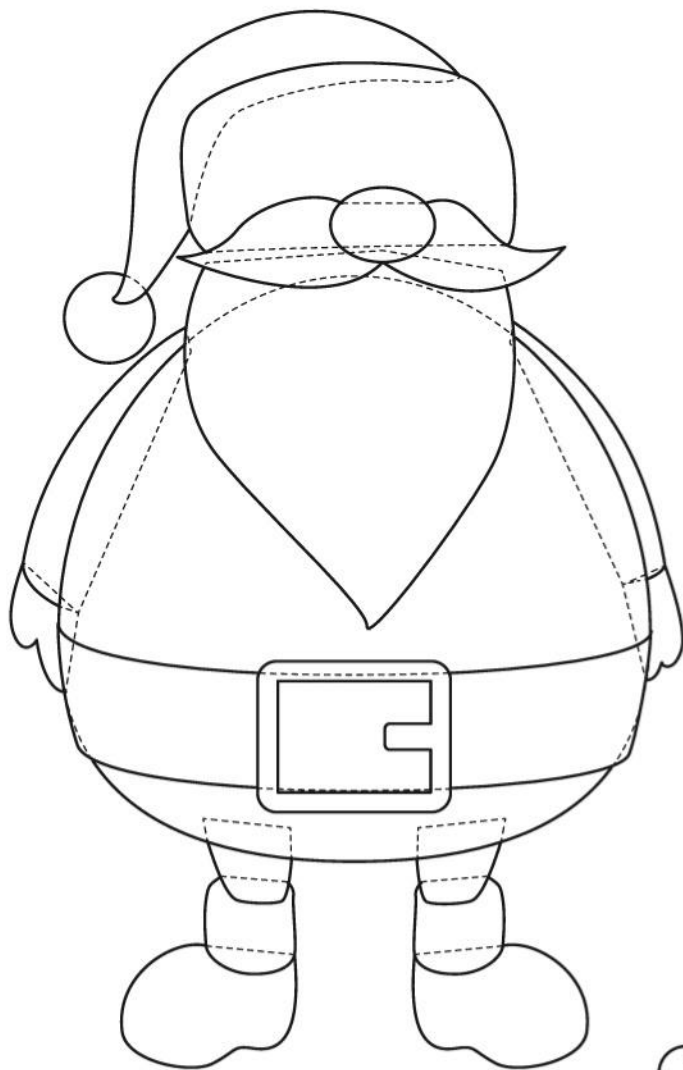

SLEIGH

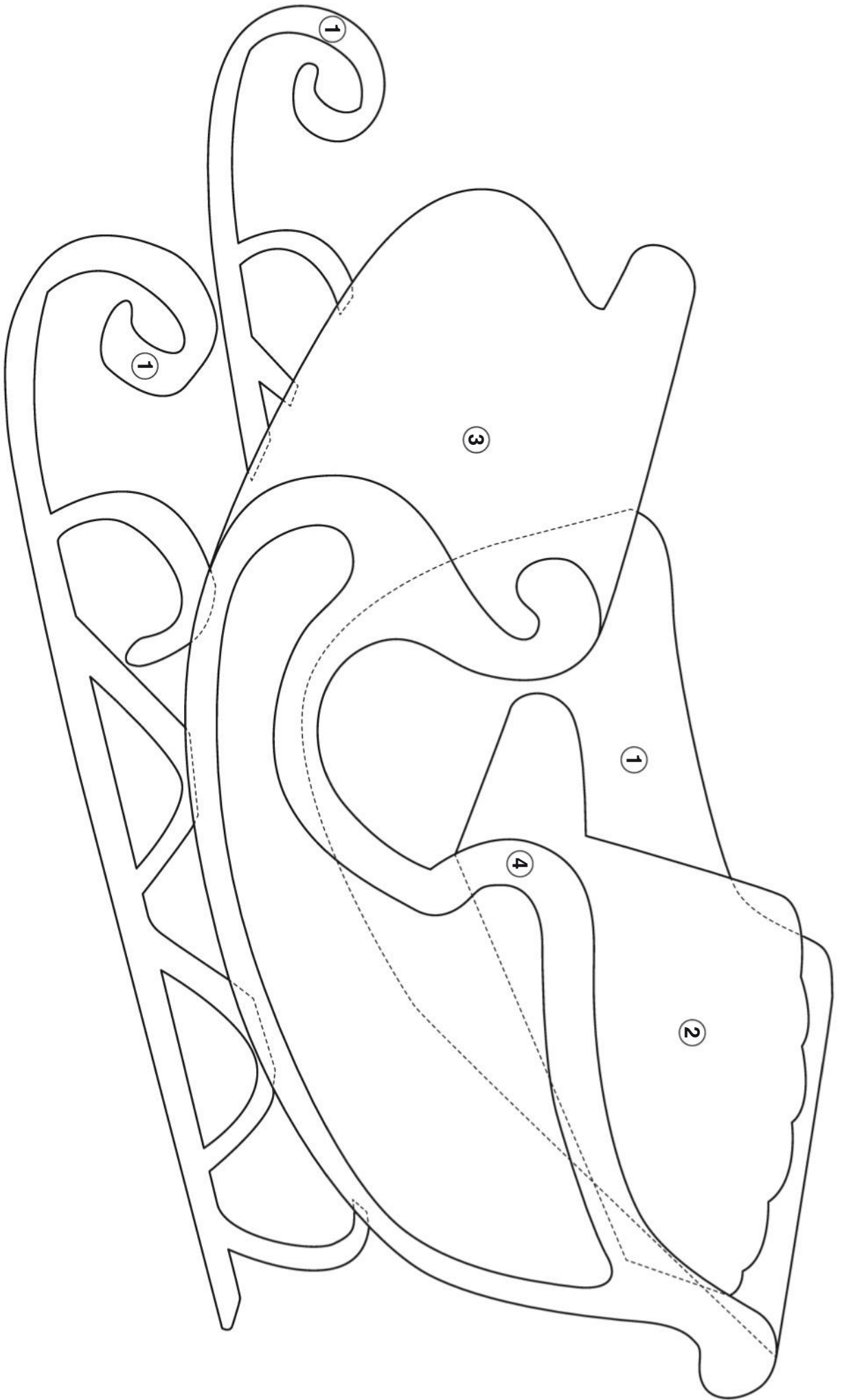

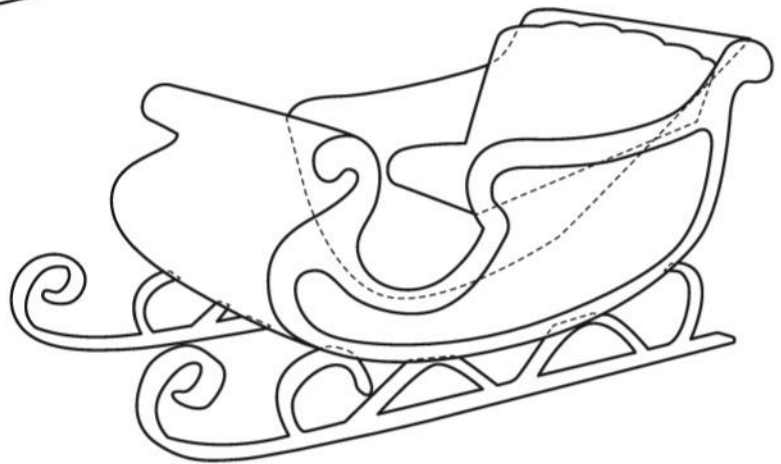
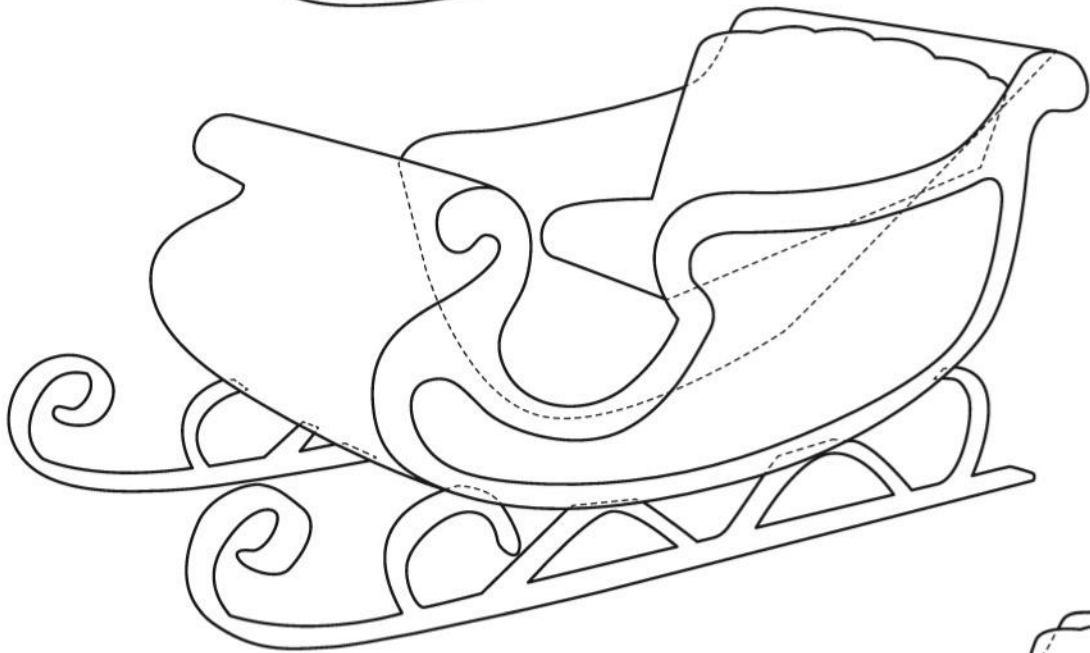
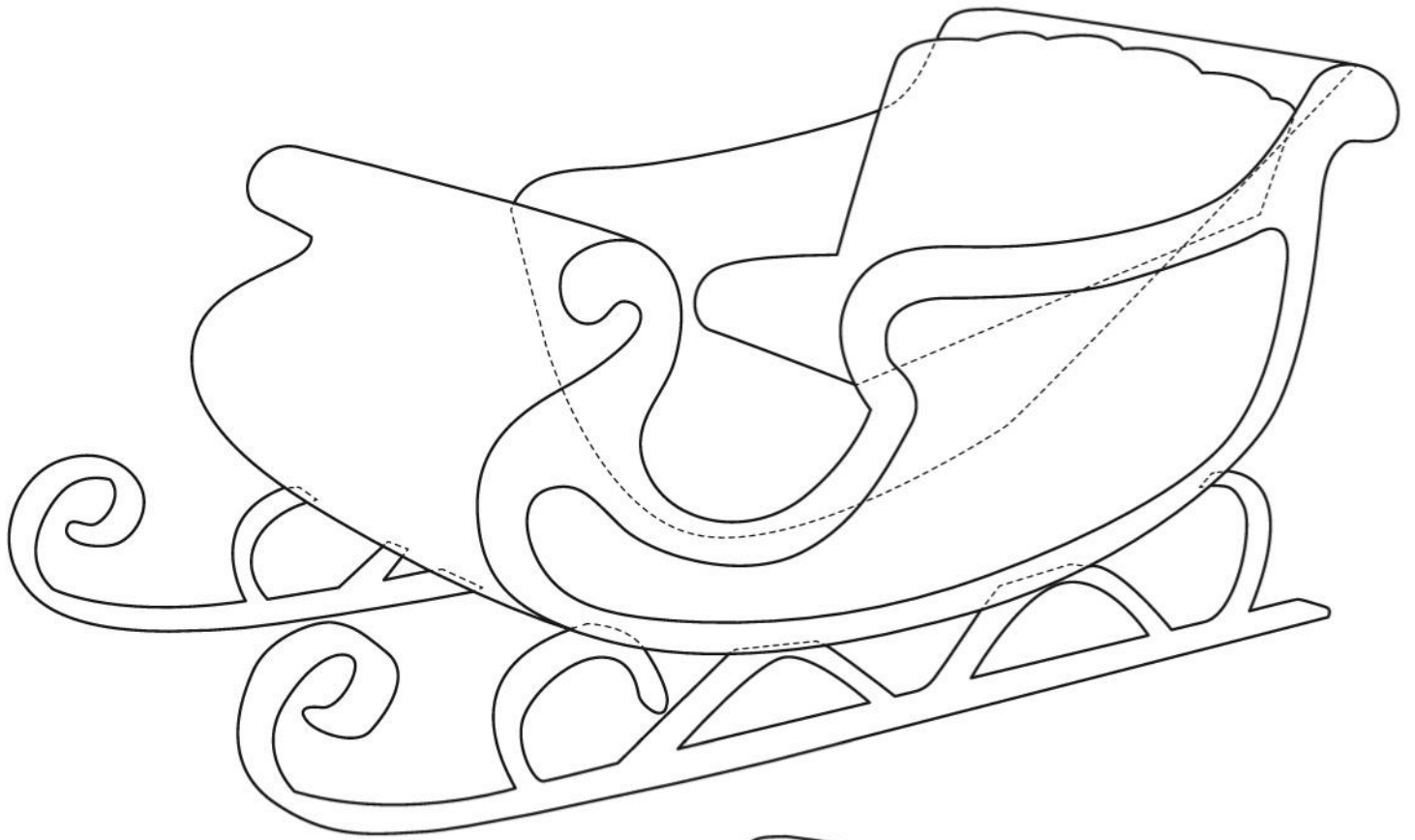

SNOWMAN

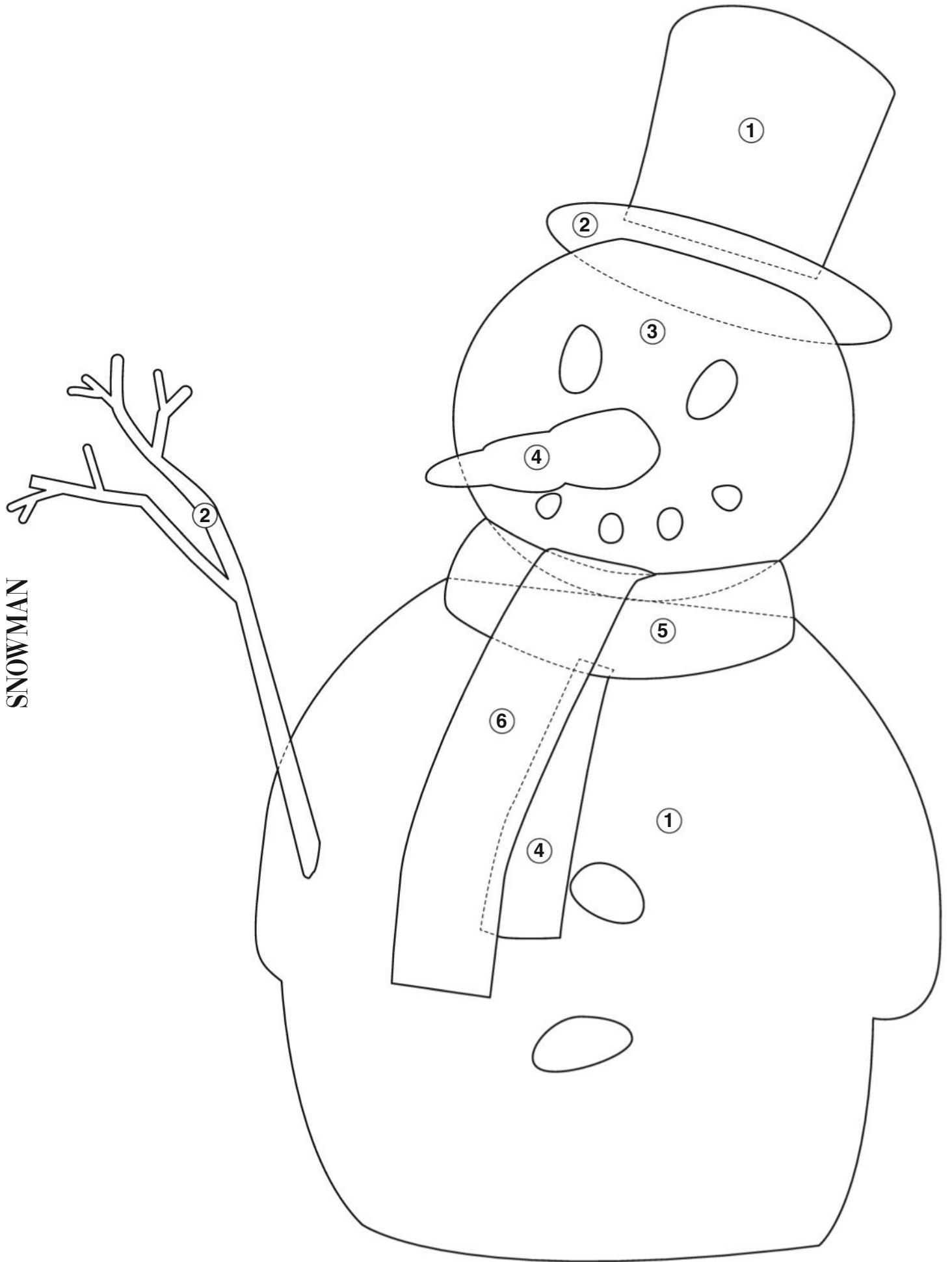



WREATH





CHRISTMAS TREE

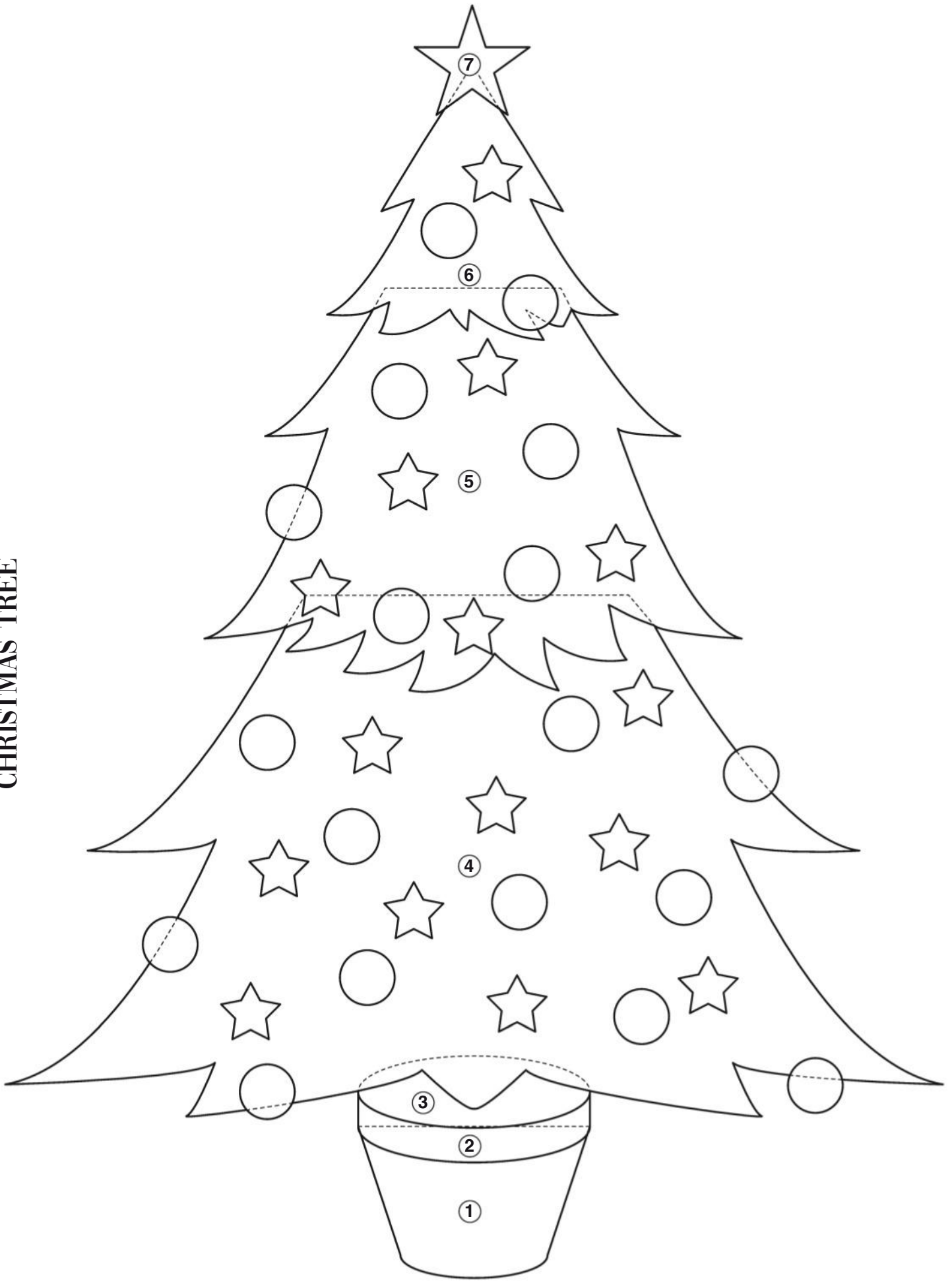

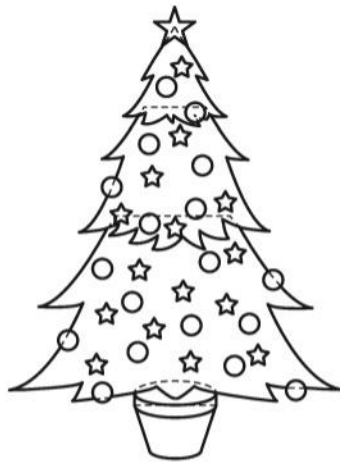
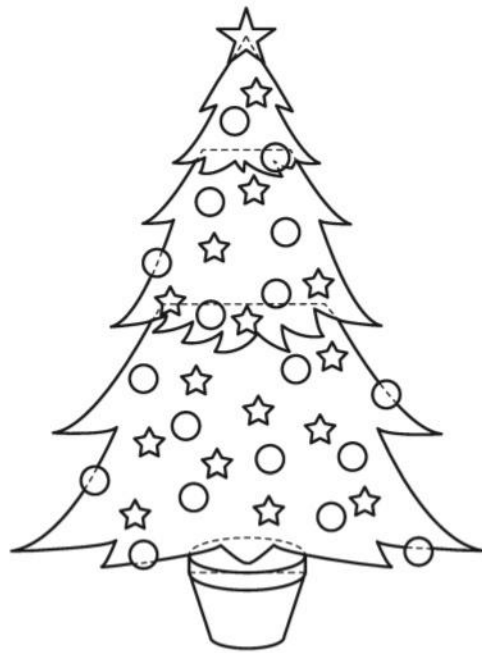
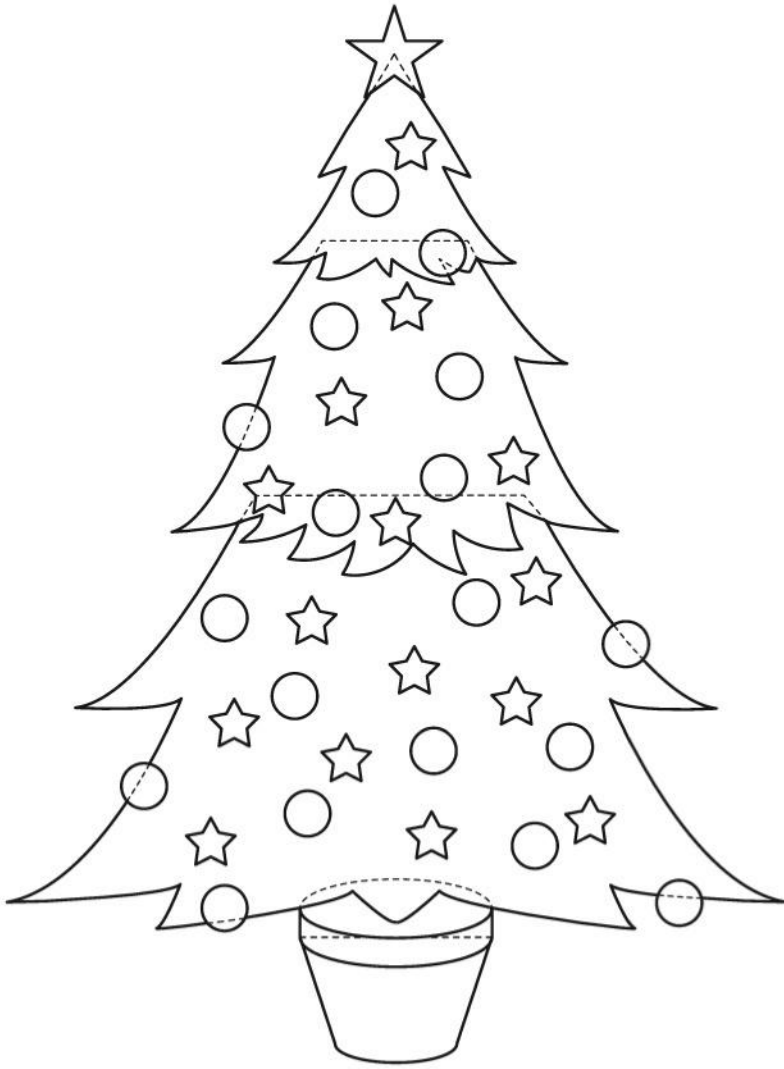

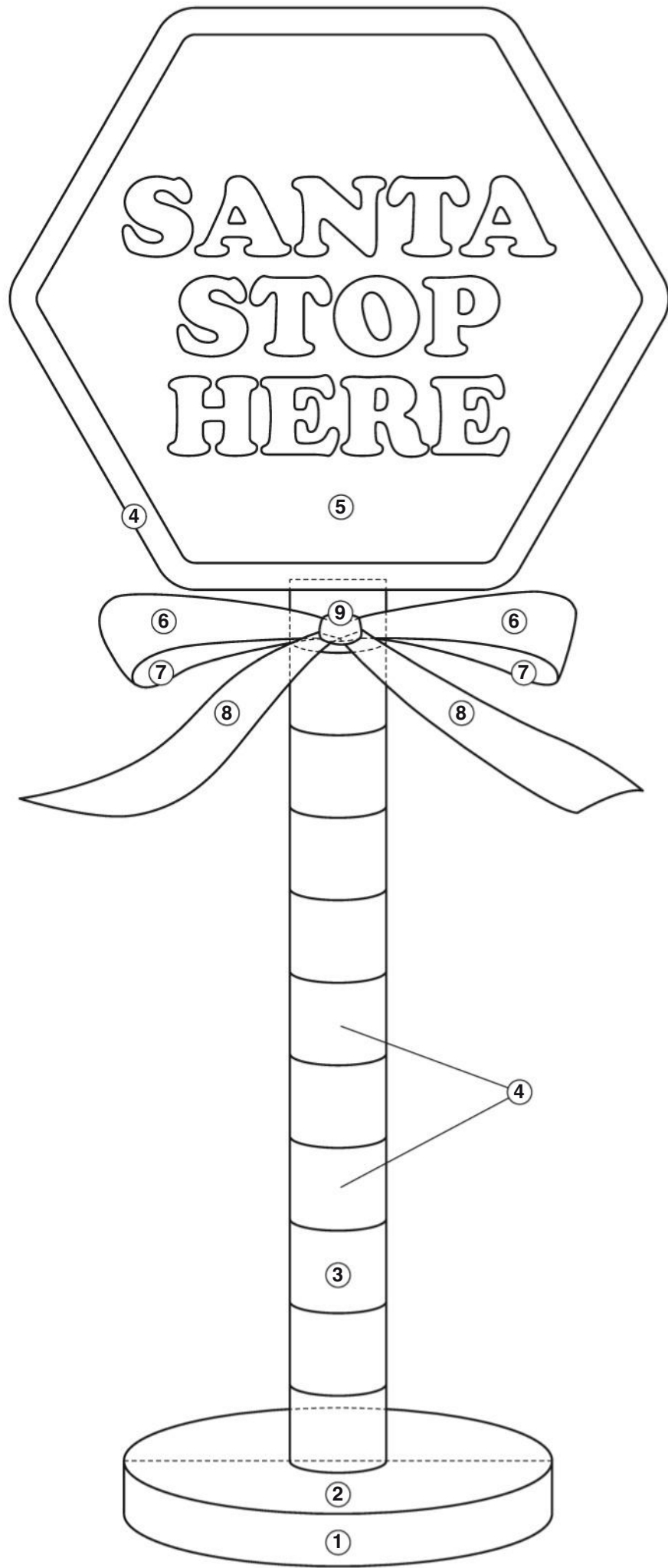

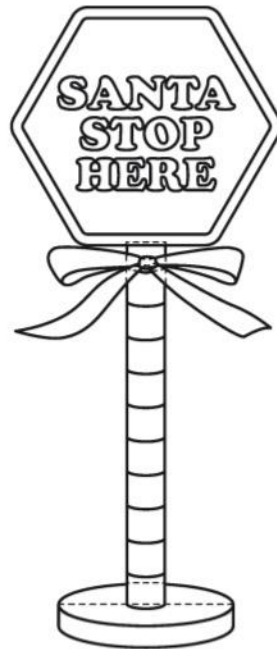
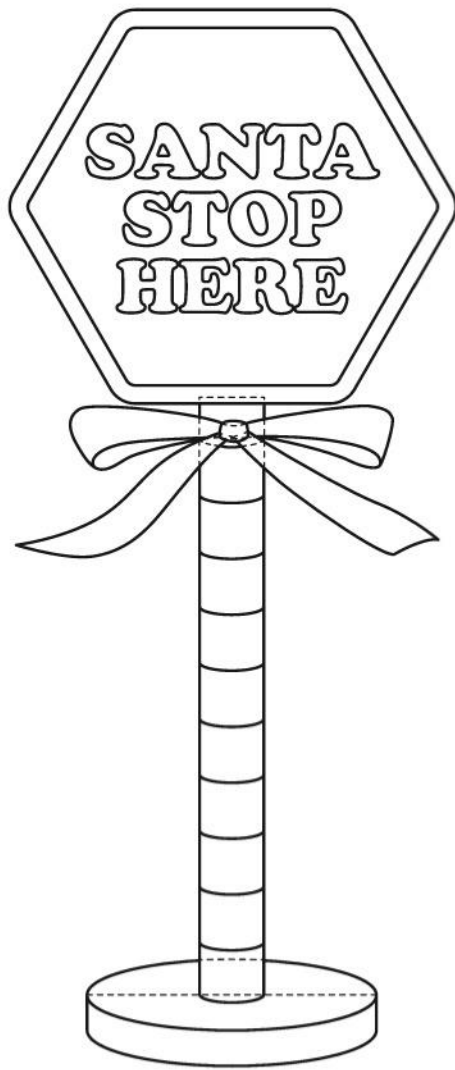

CANDY CANE

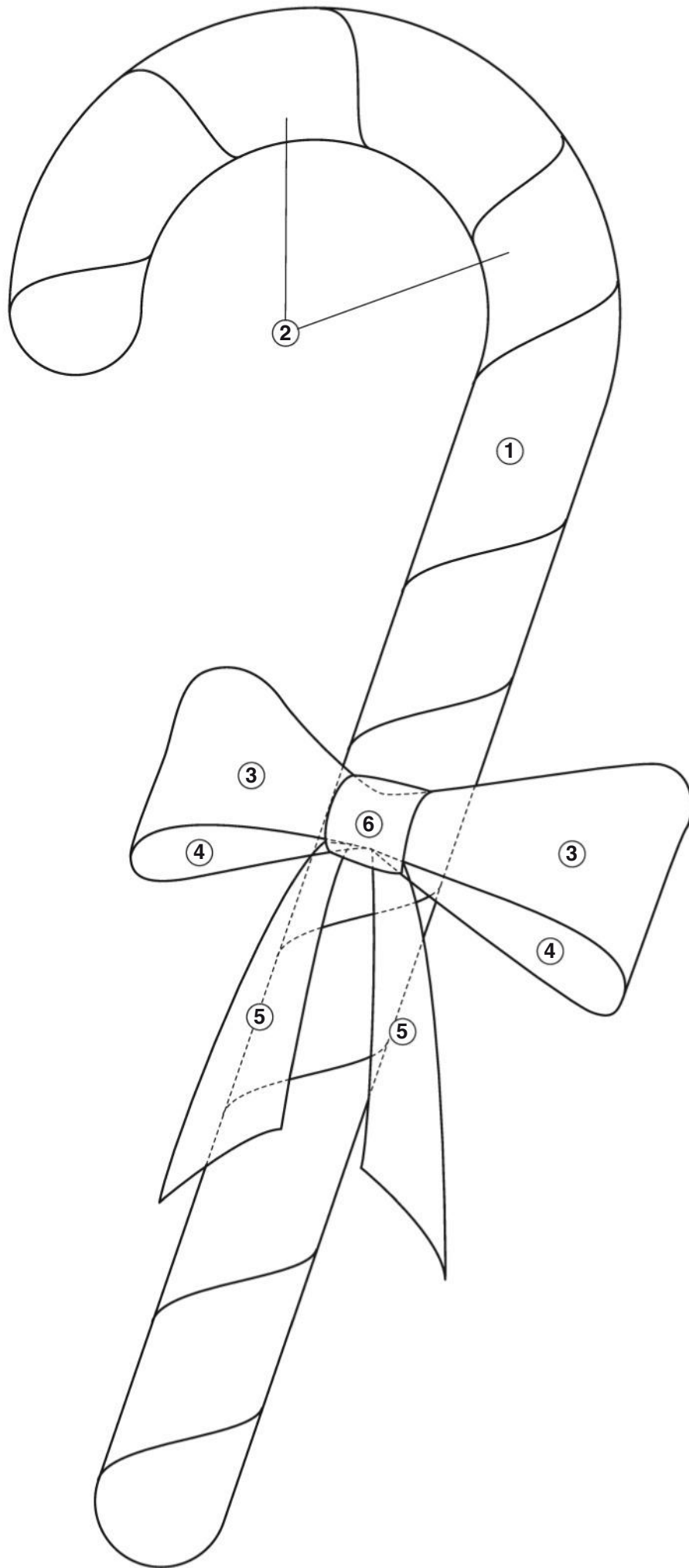

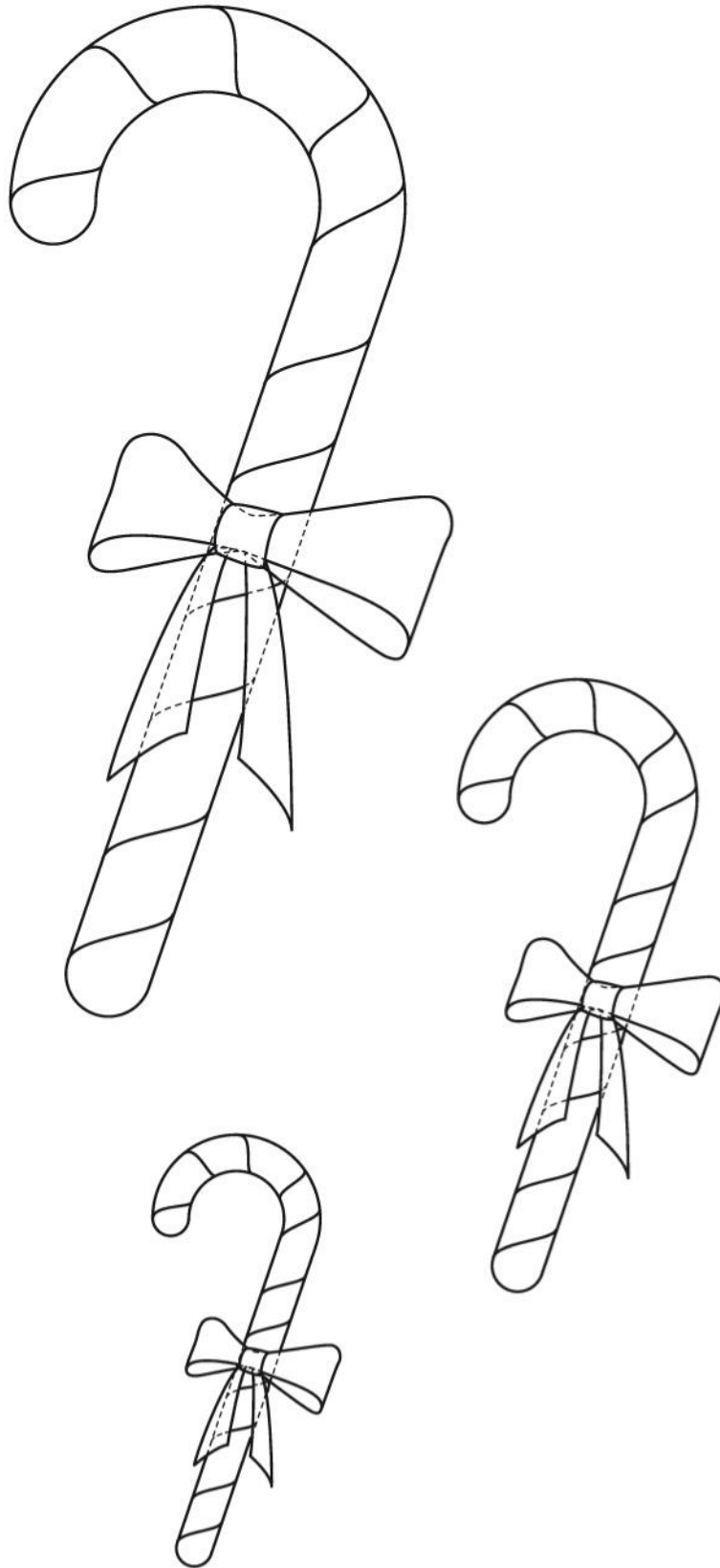

SANTA HAT

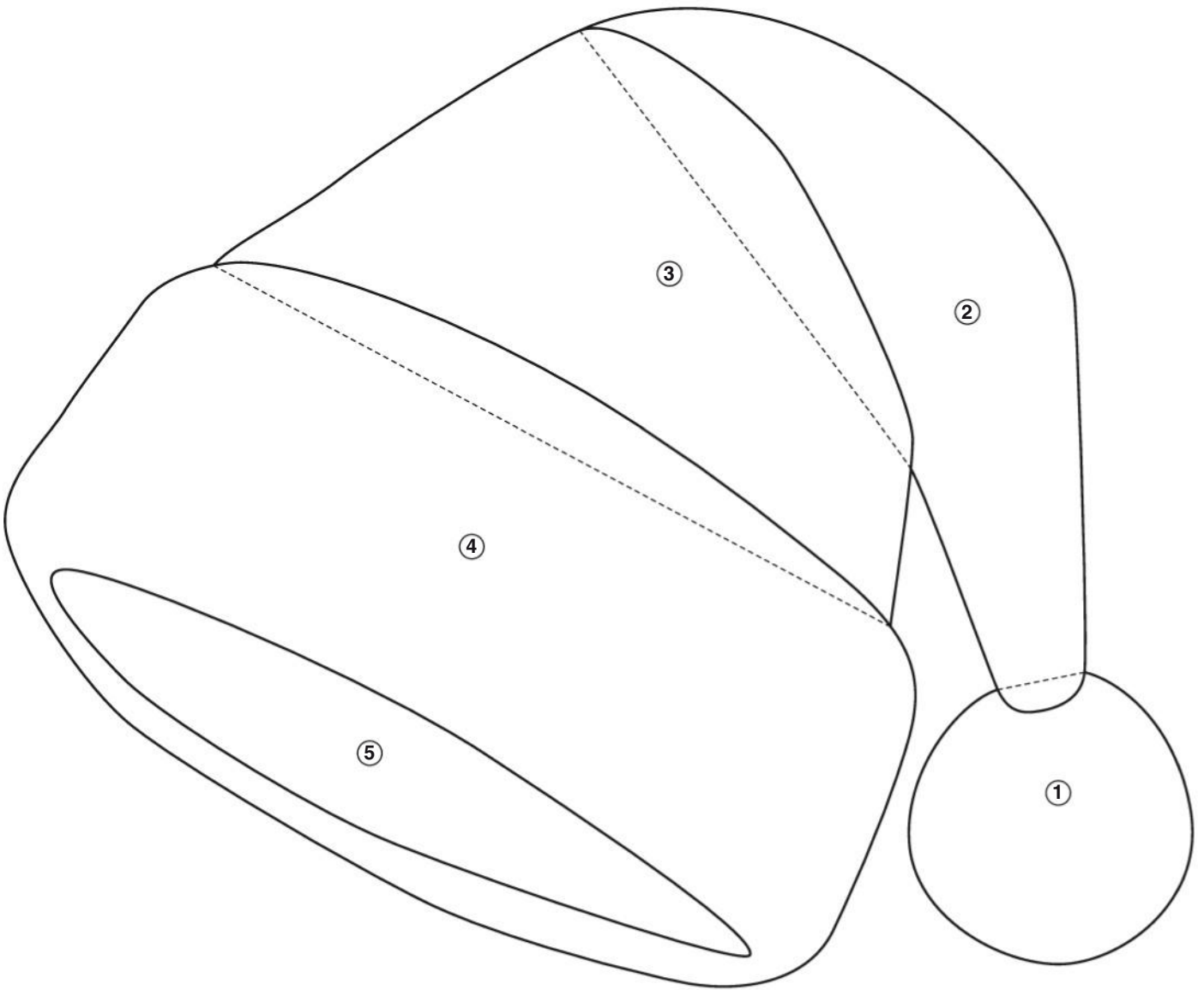

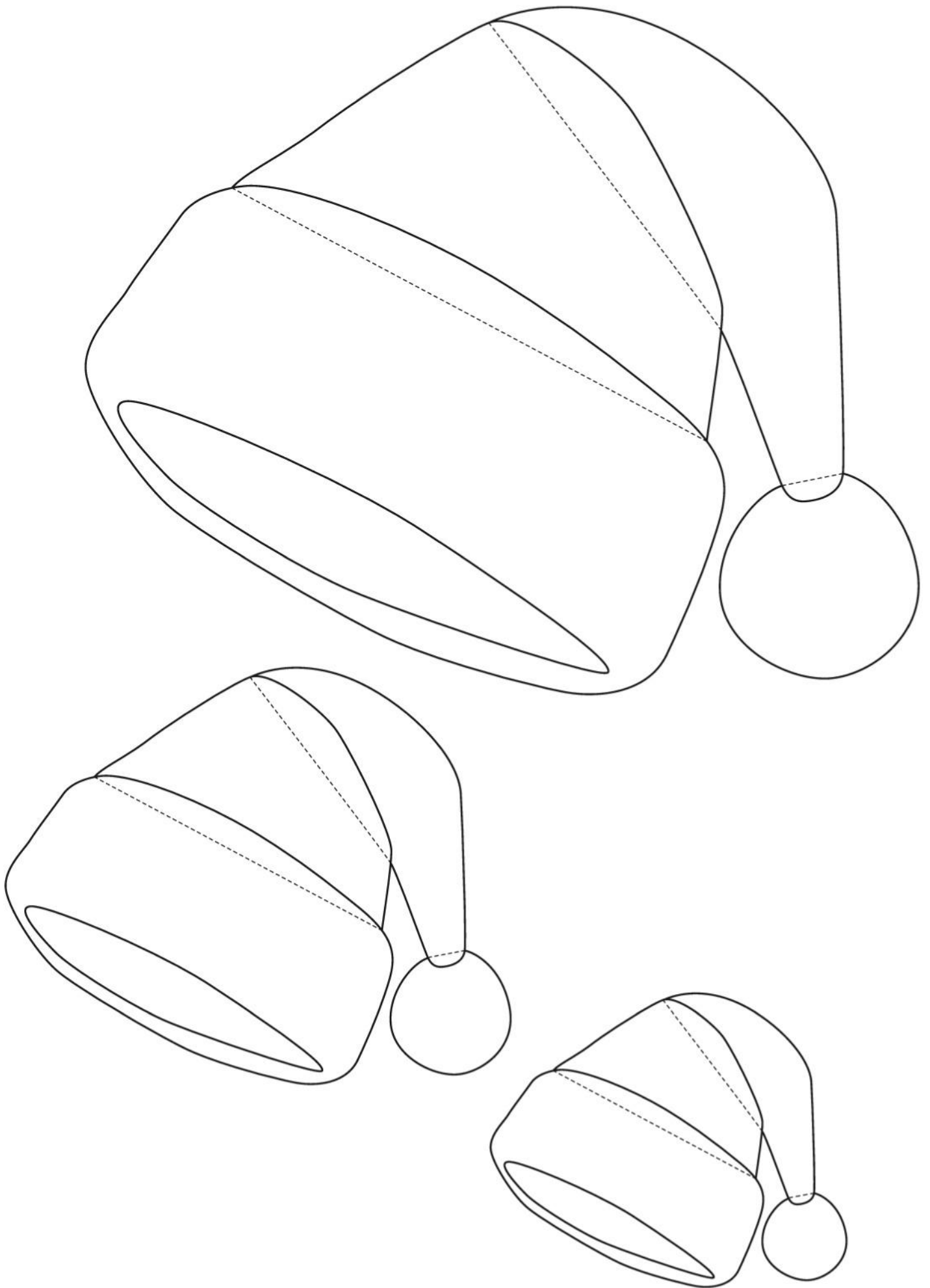

BOW

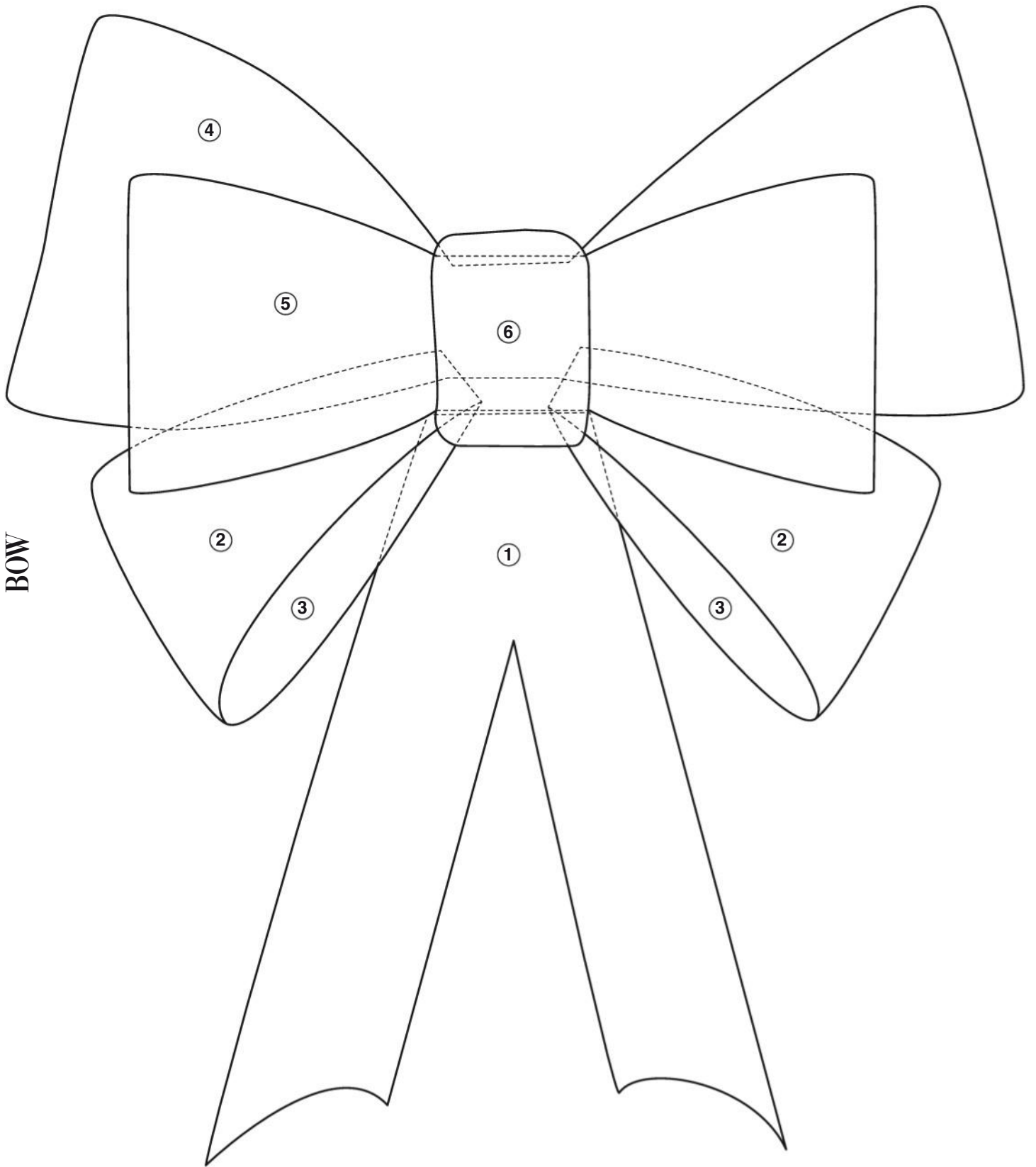

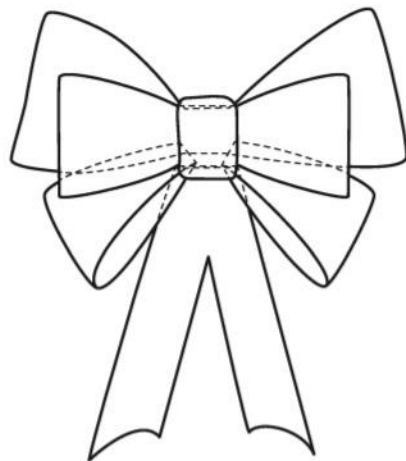
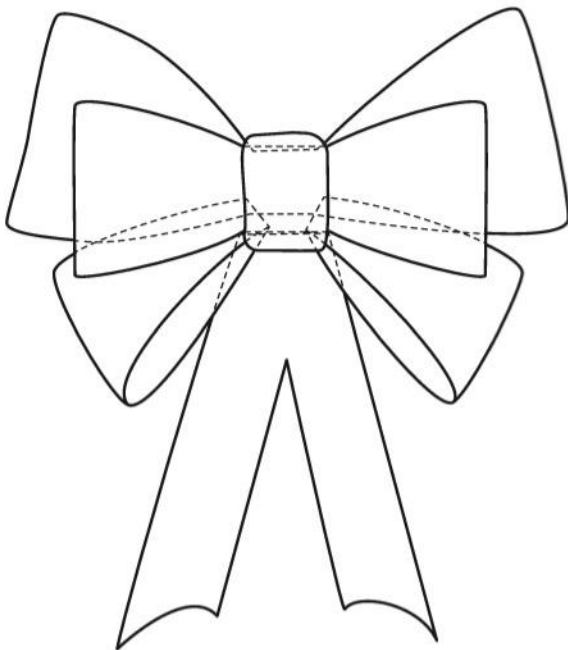
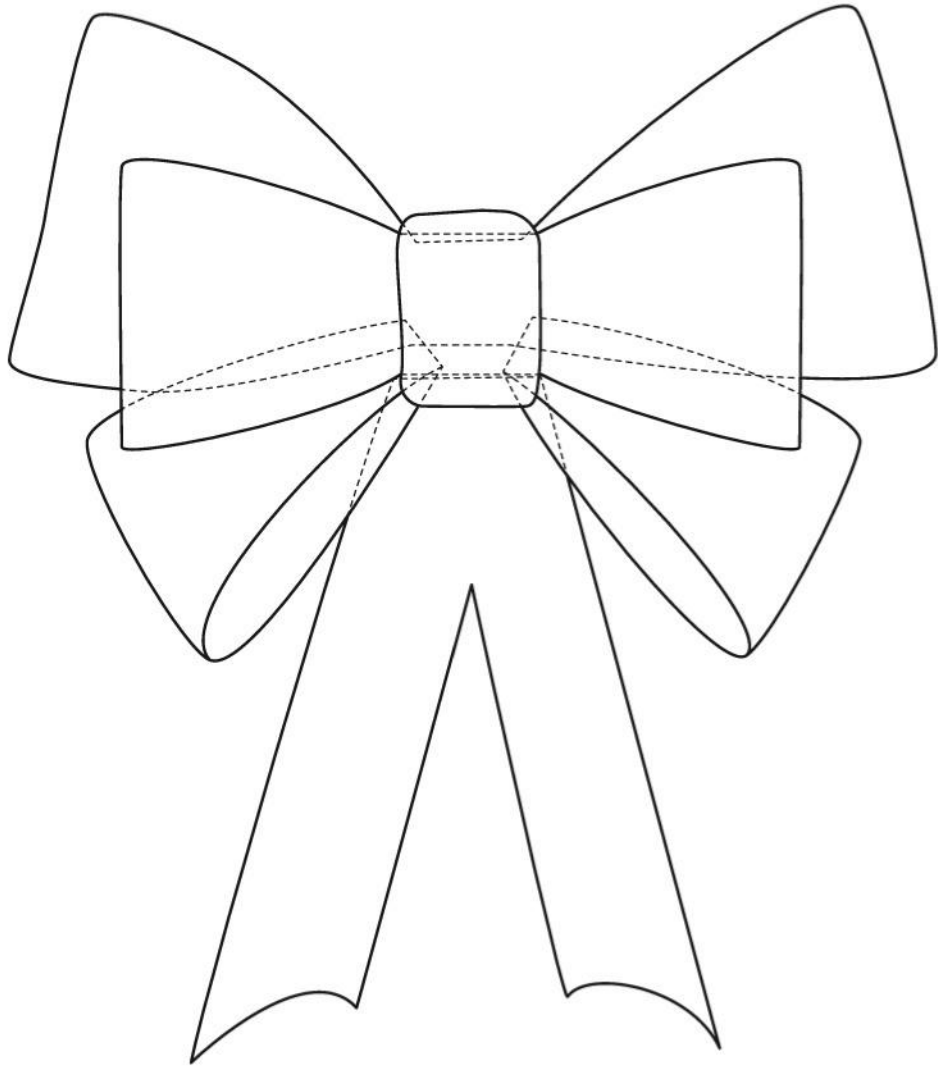

BOOTS

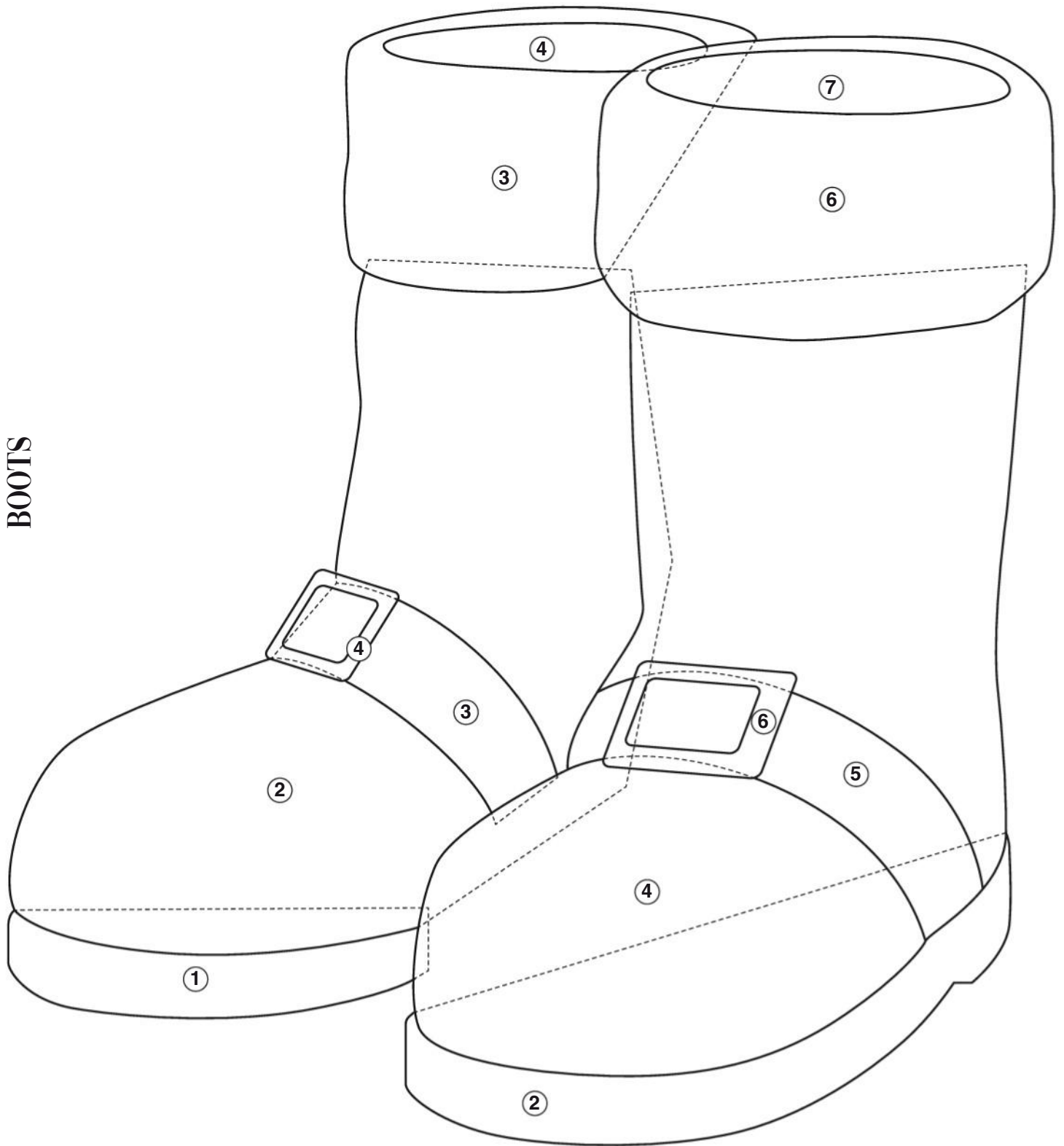



MITTENS

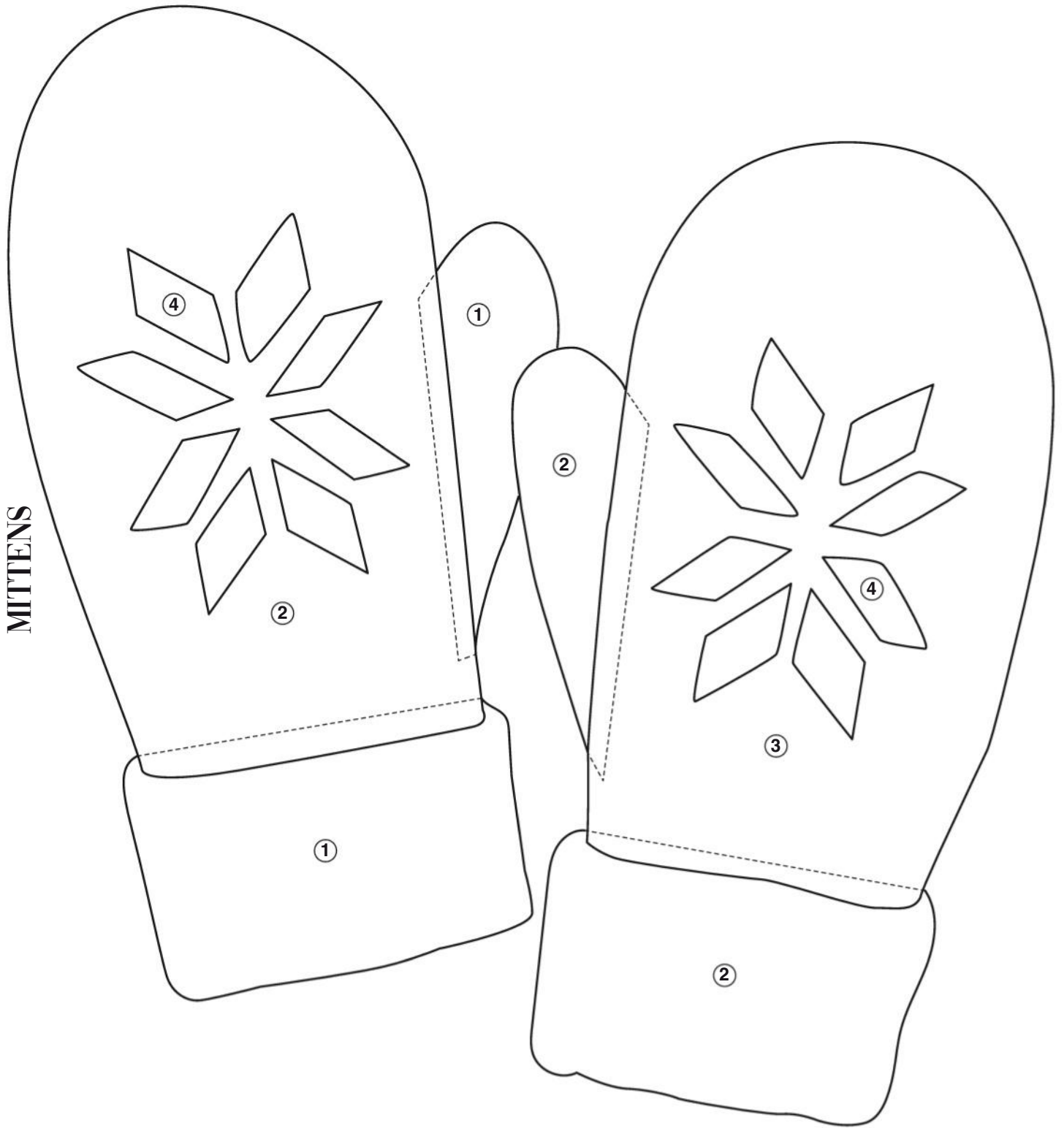



LIGHTS

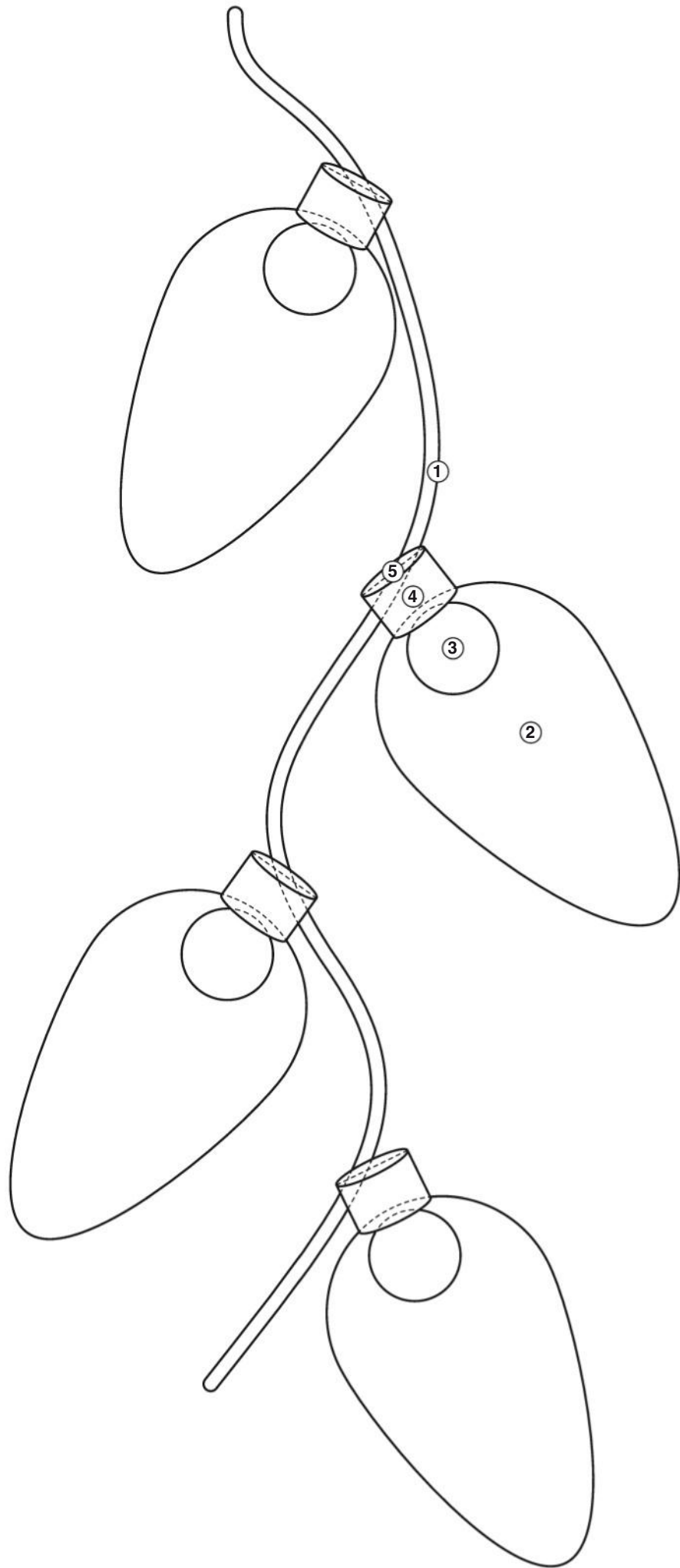

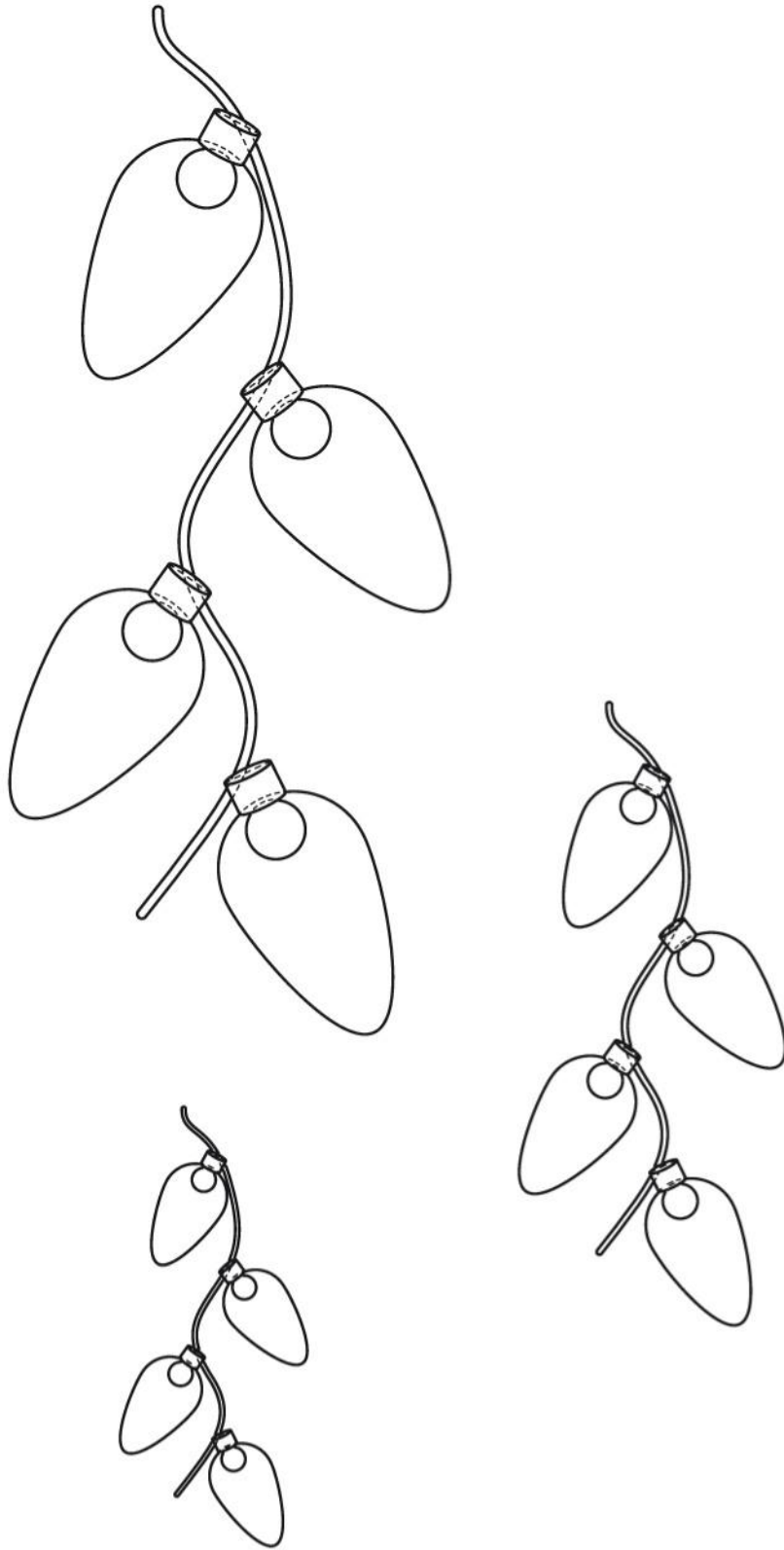

HOUSE





POLAR BEAR

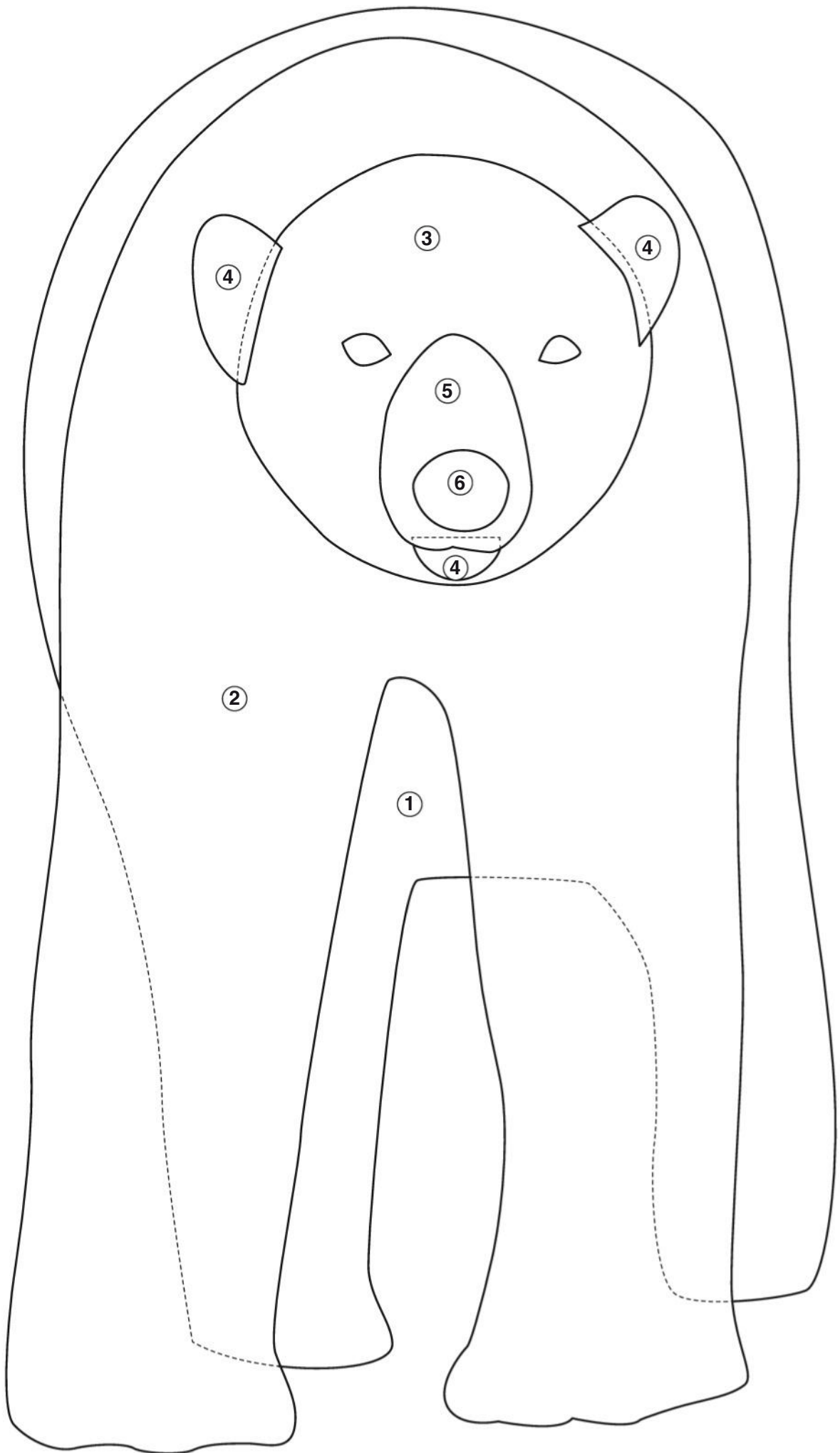

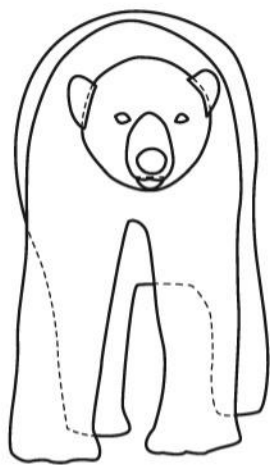
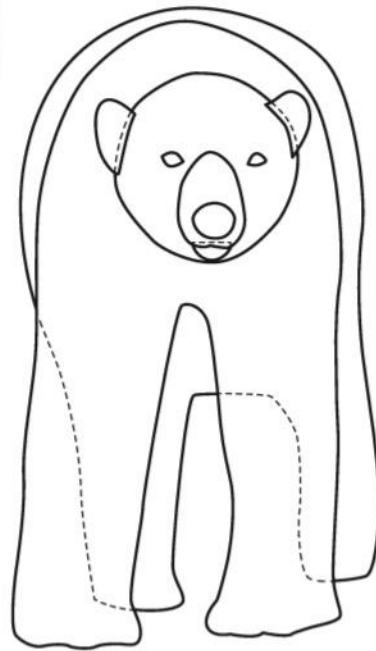
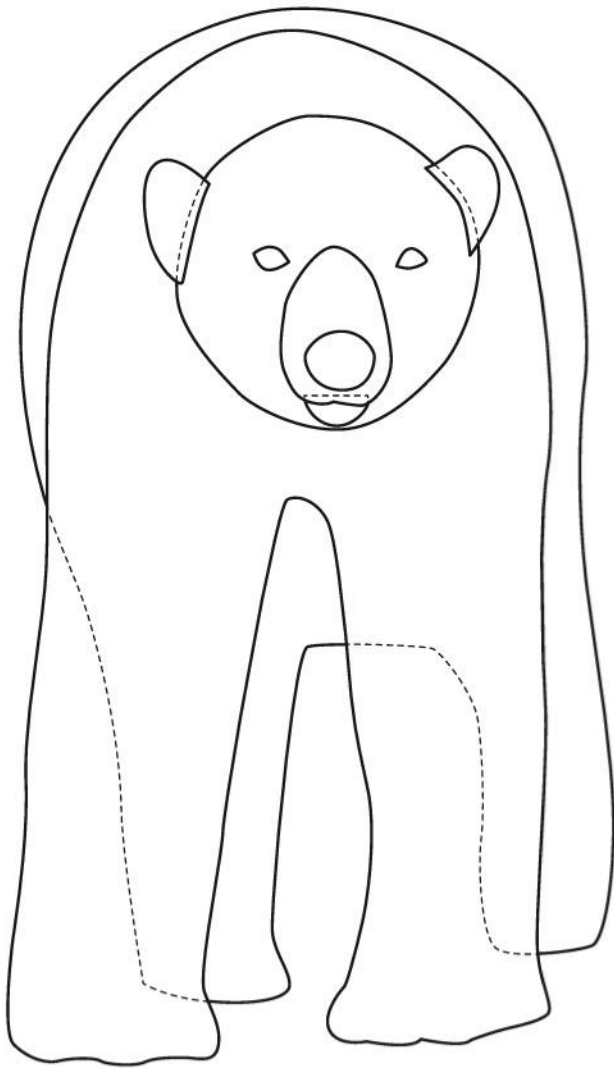

CHIMNEY

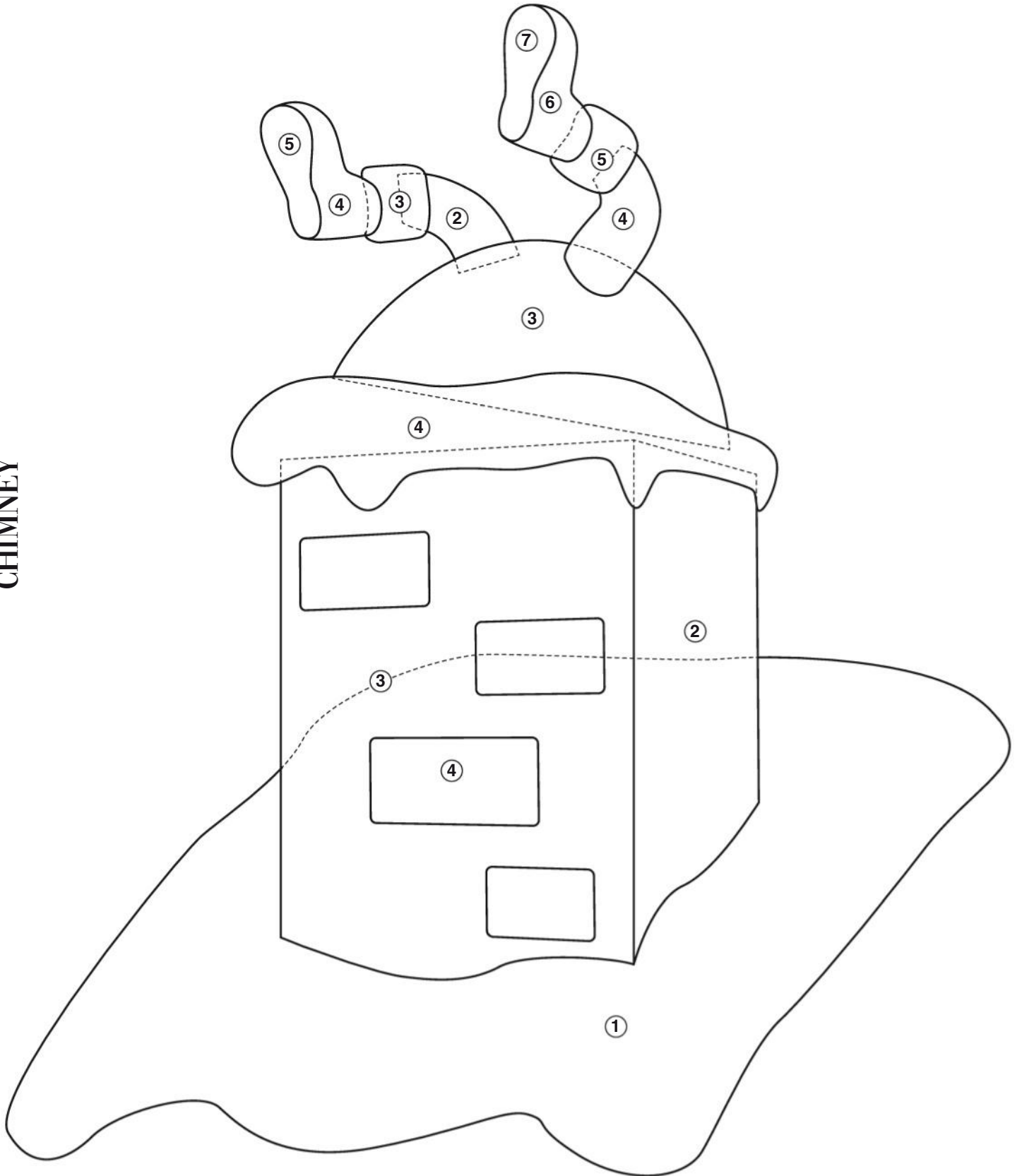

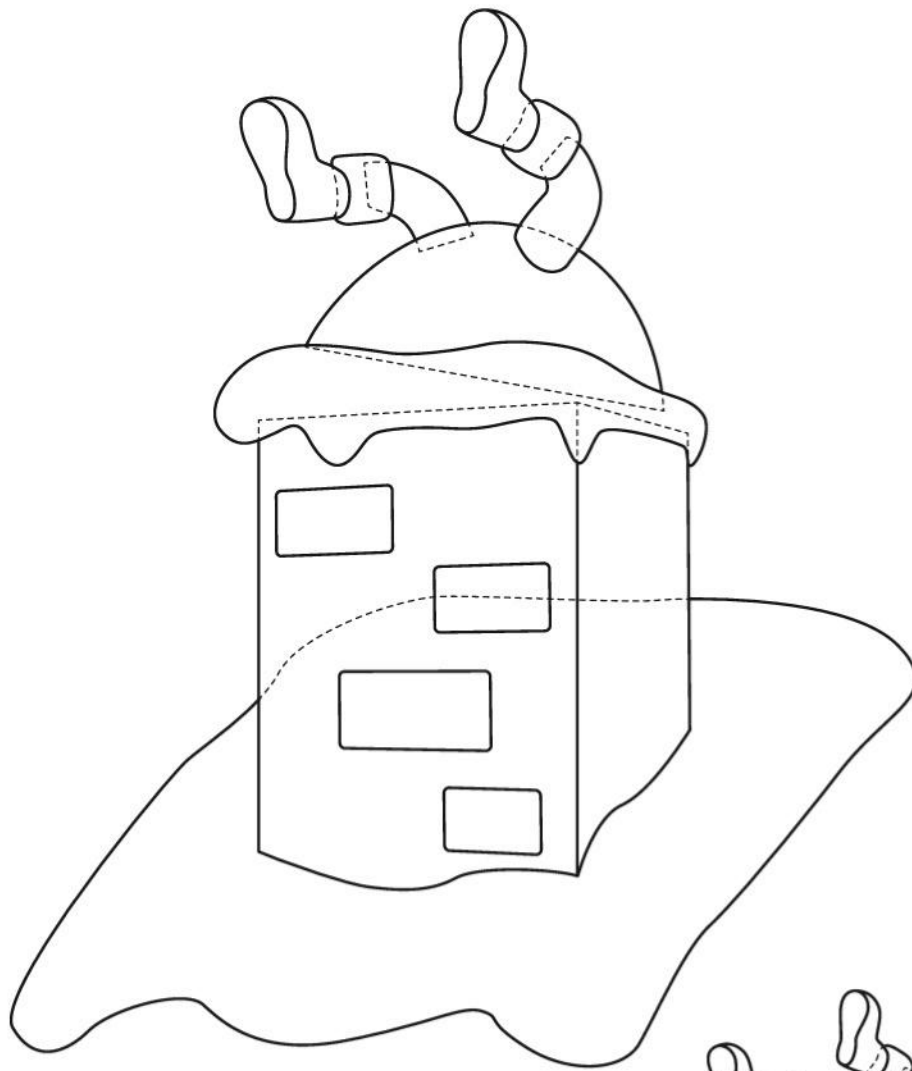

ADVENT CALENDAR

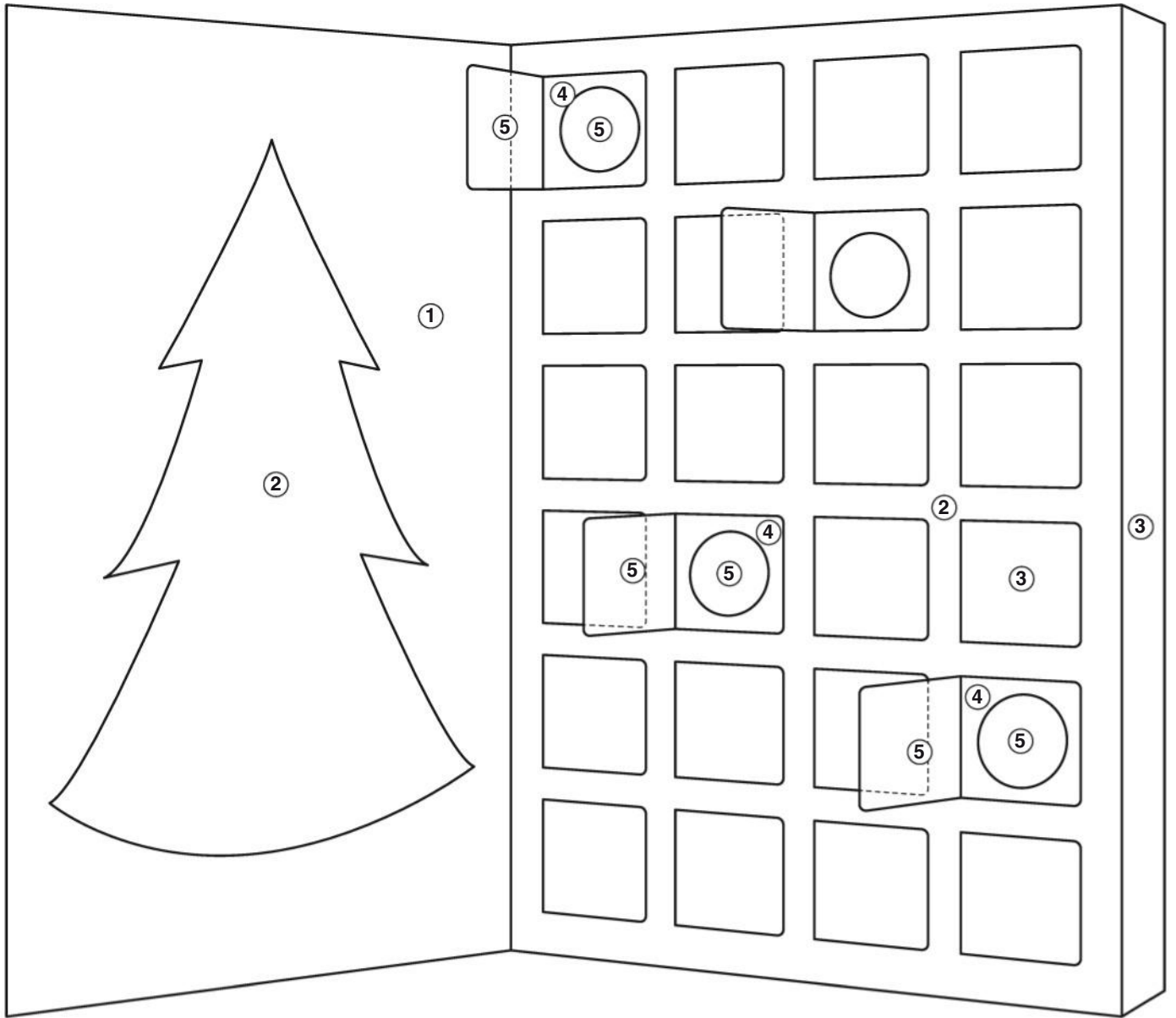

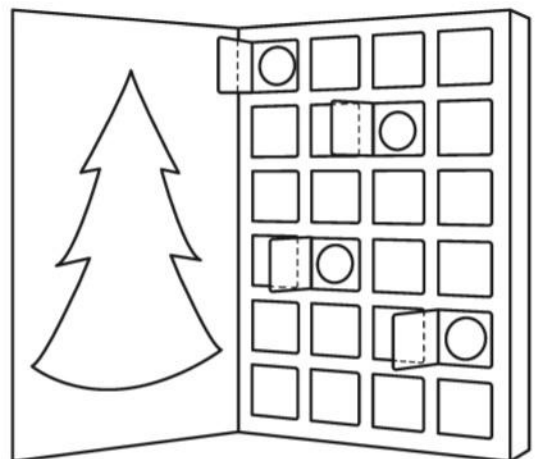
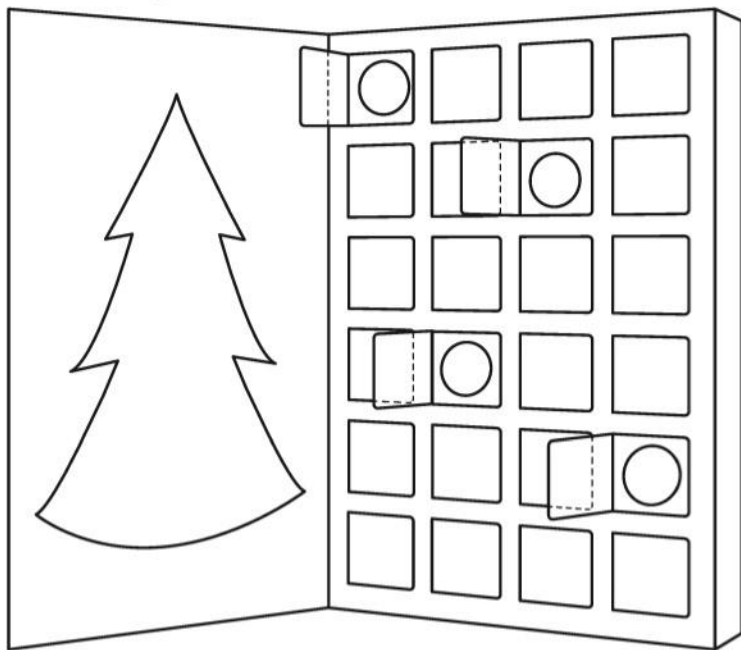
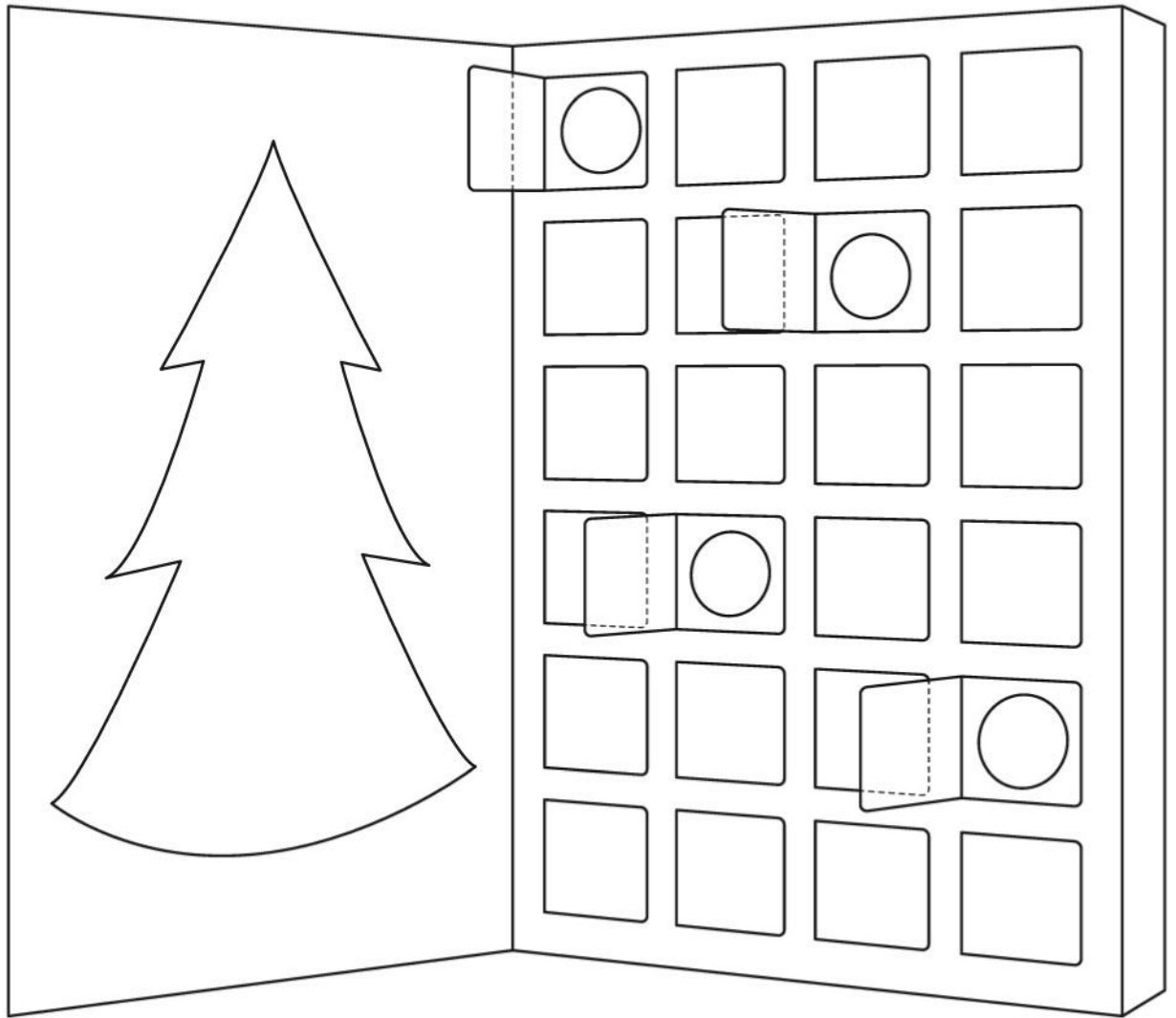

WINE

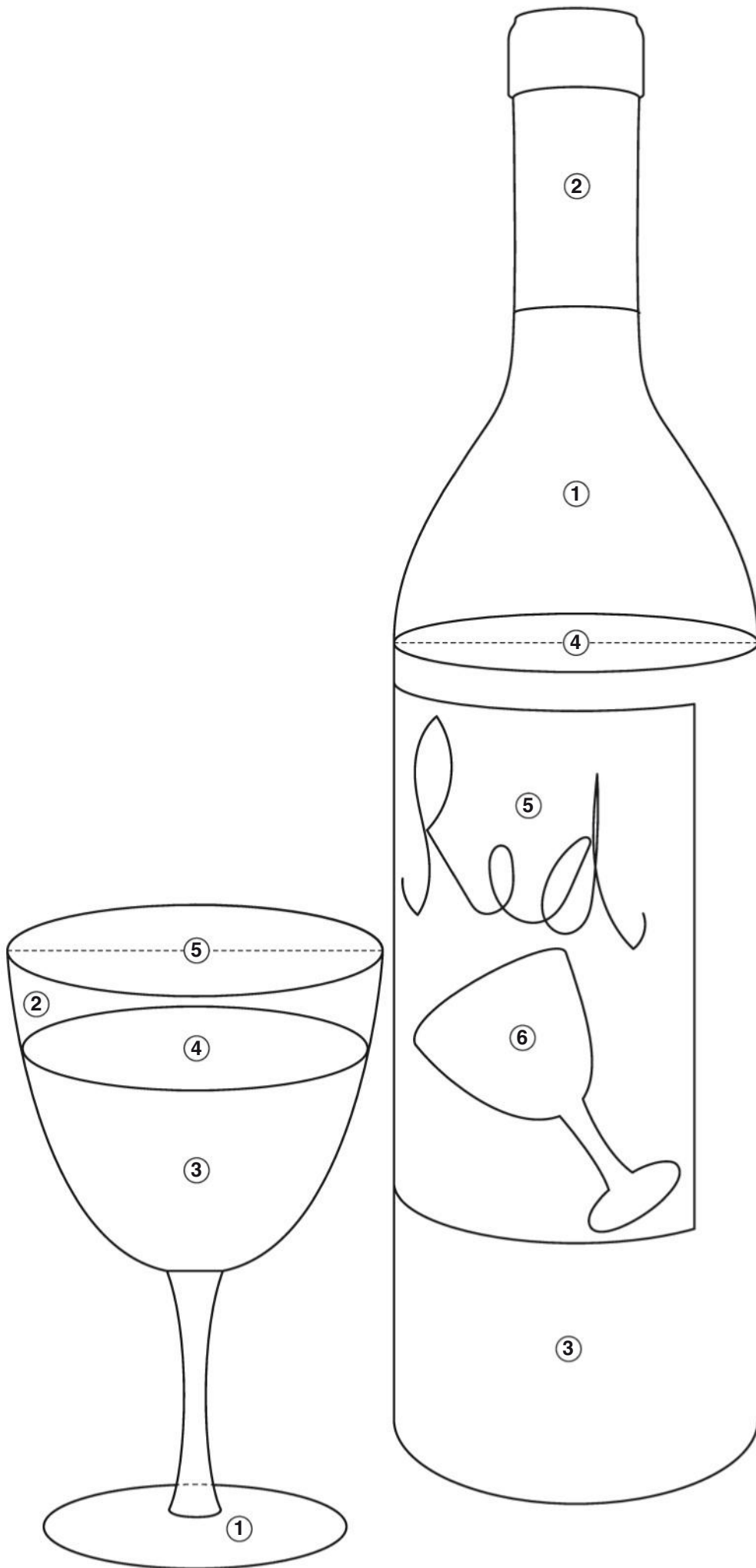



SACK

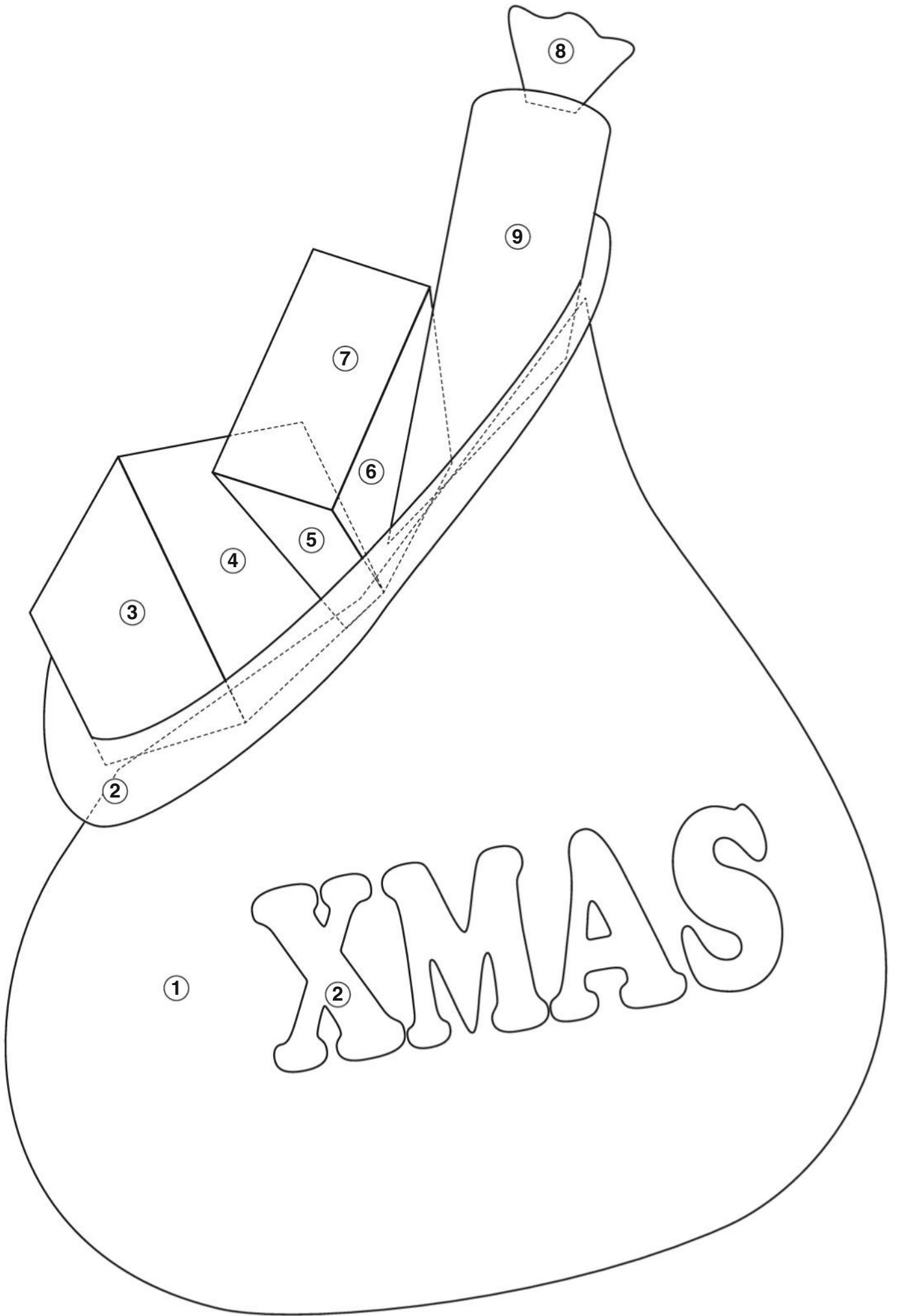



HOLLY

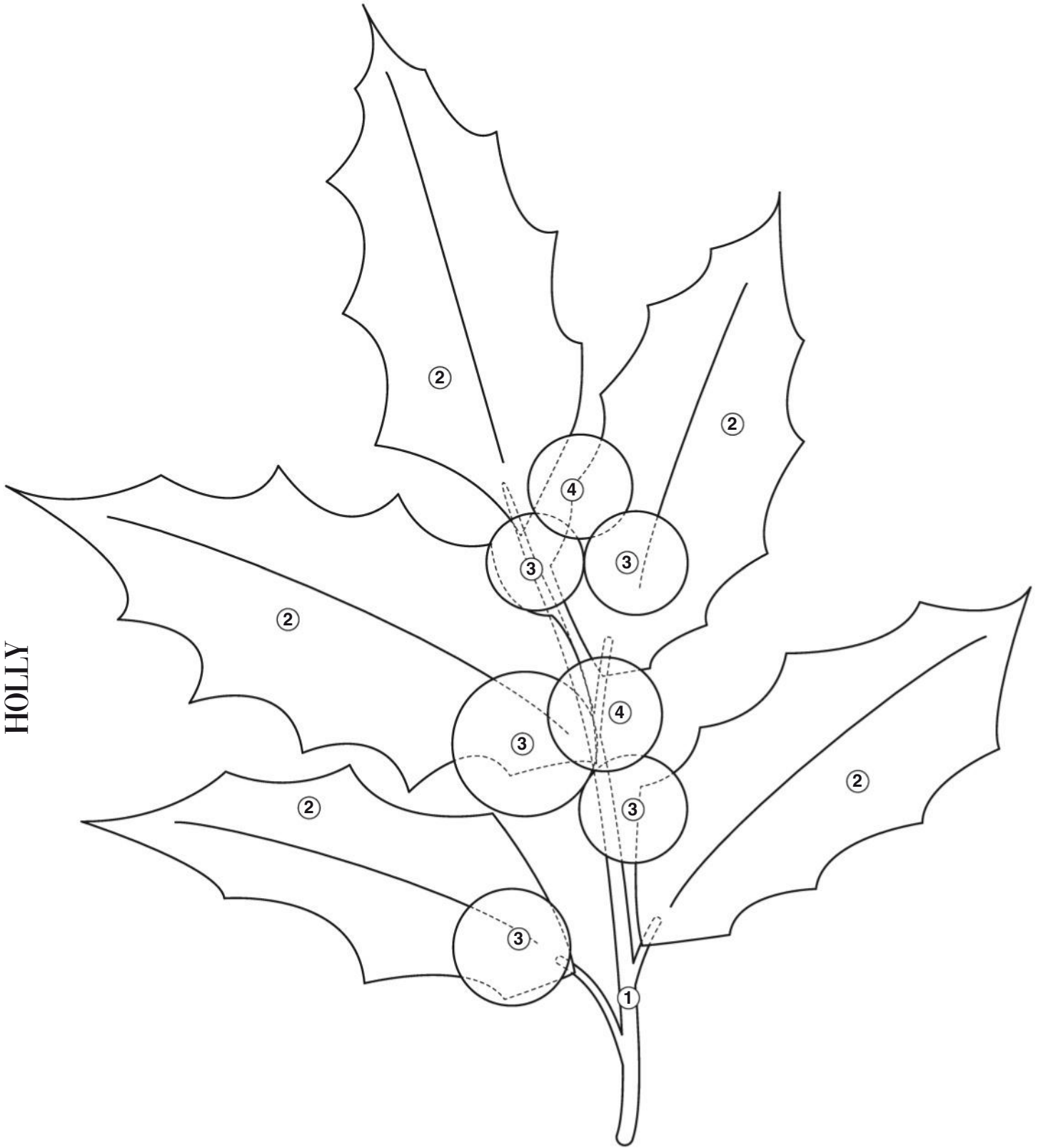

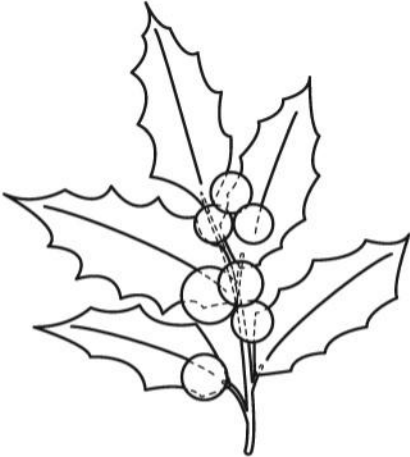
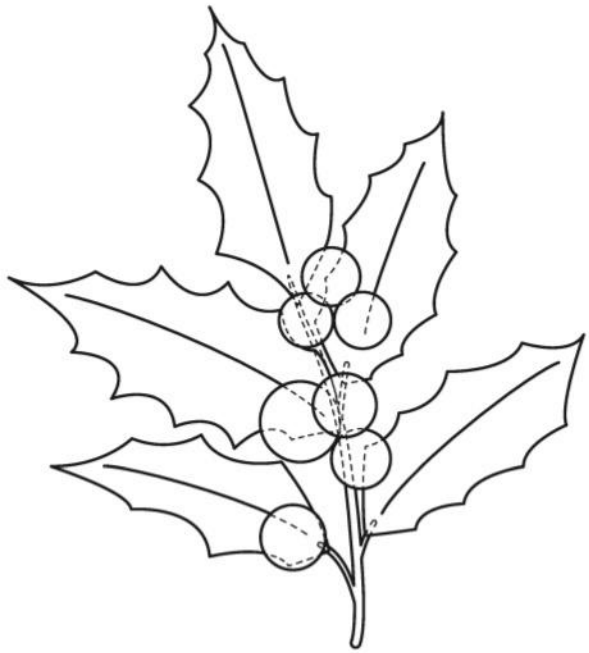
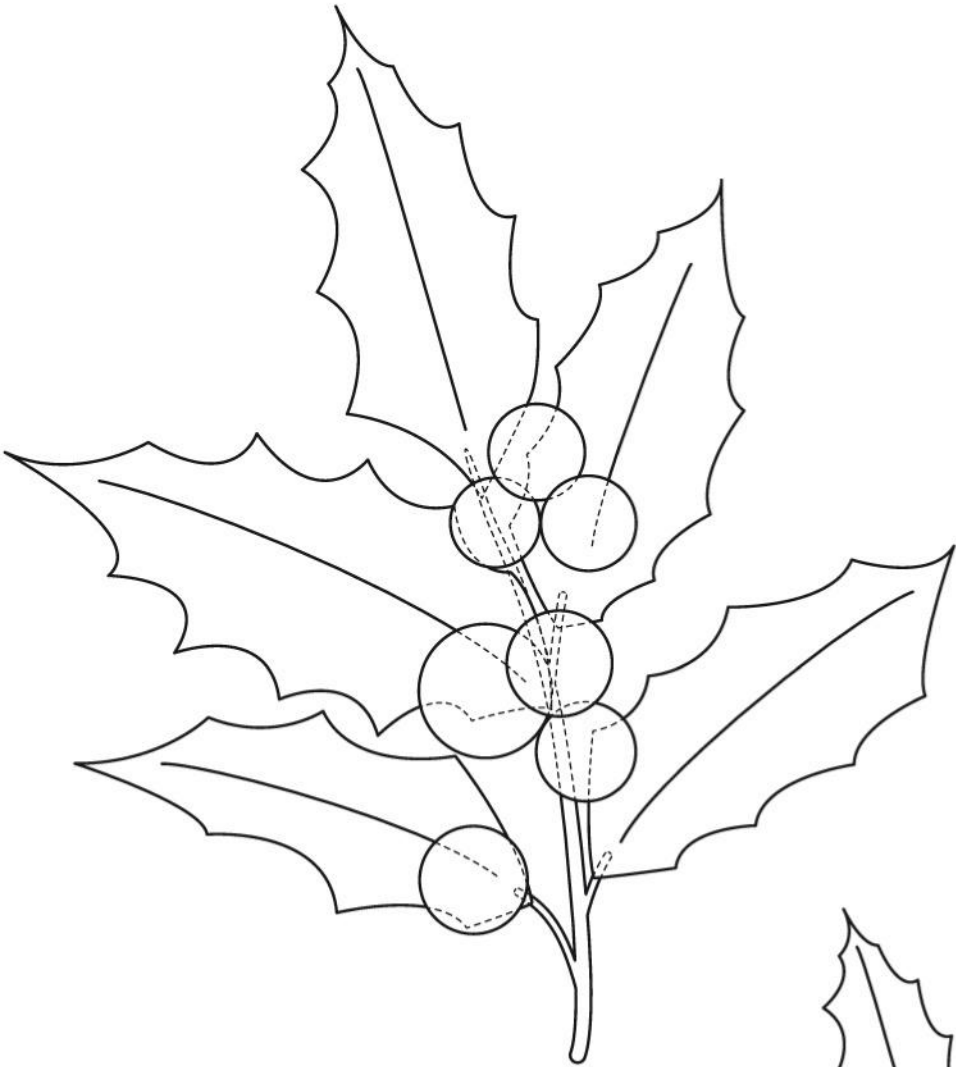

COOKIES

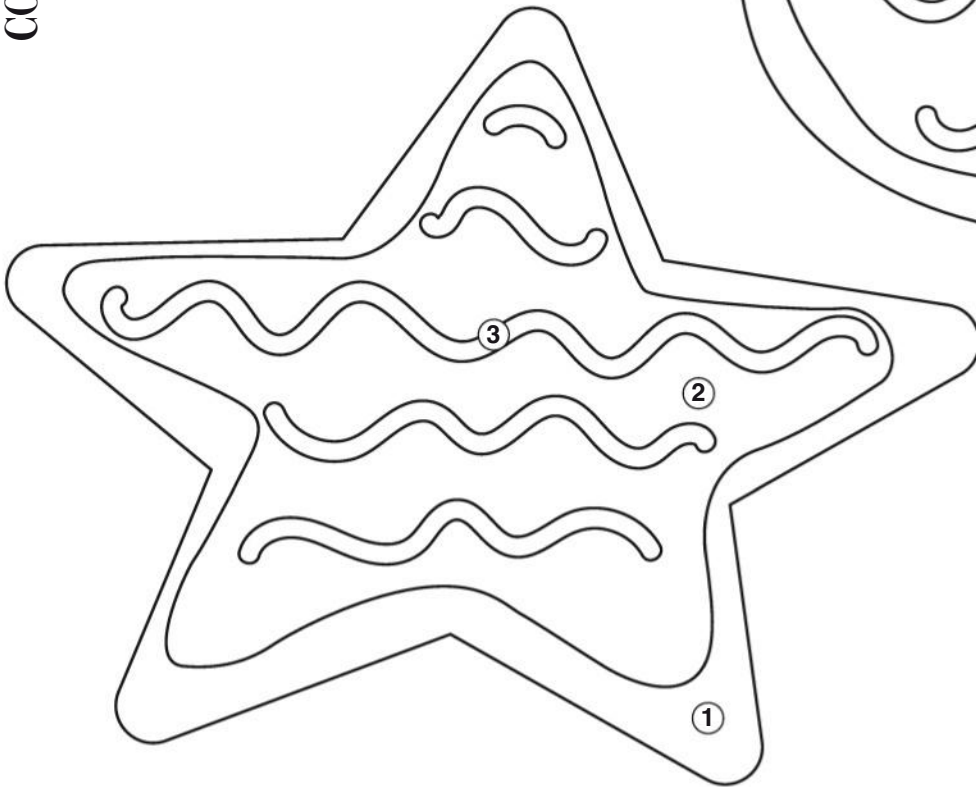
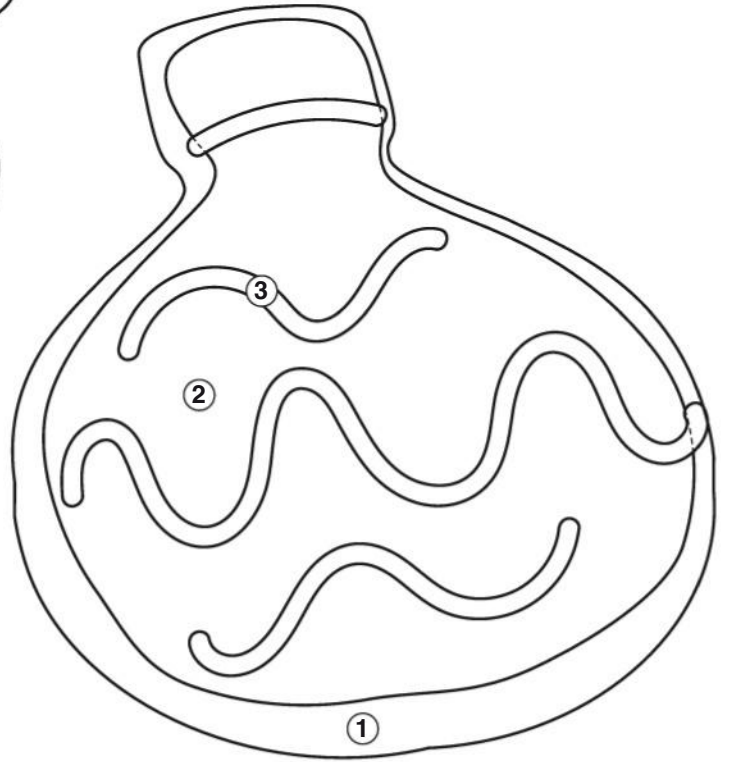
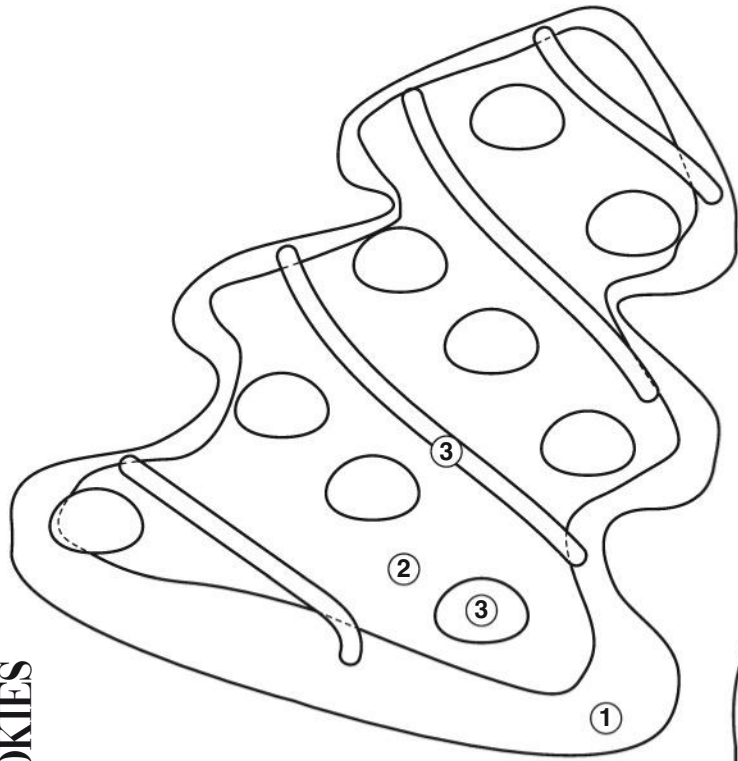

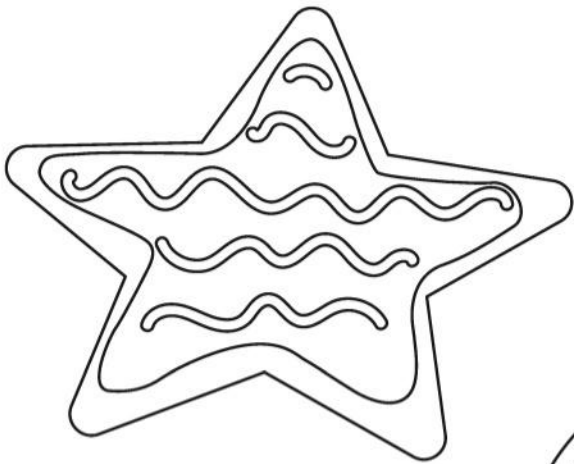
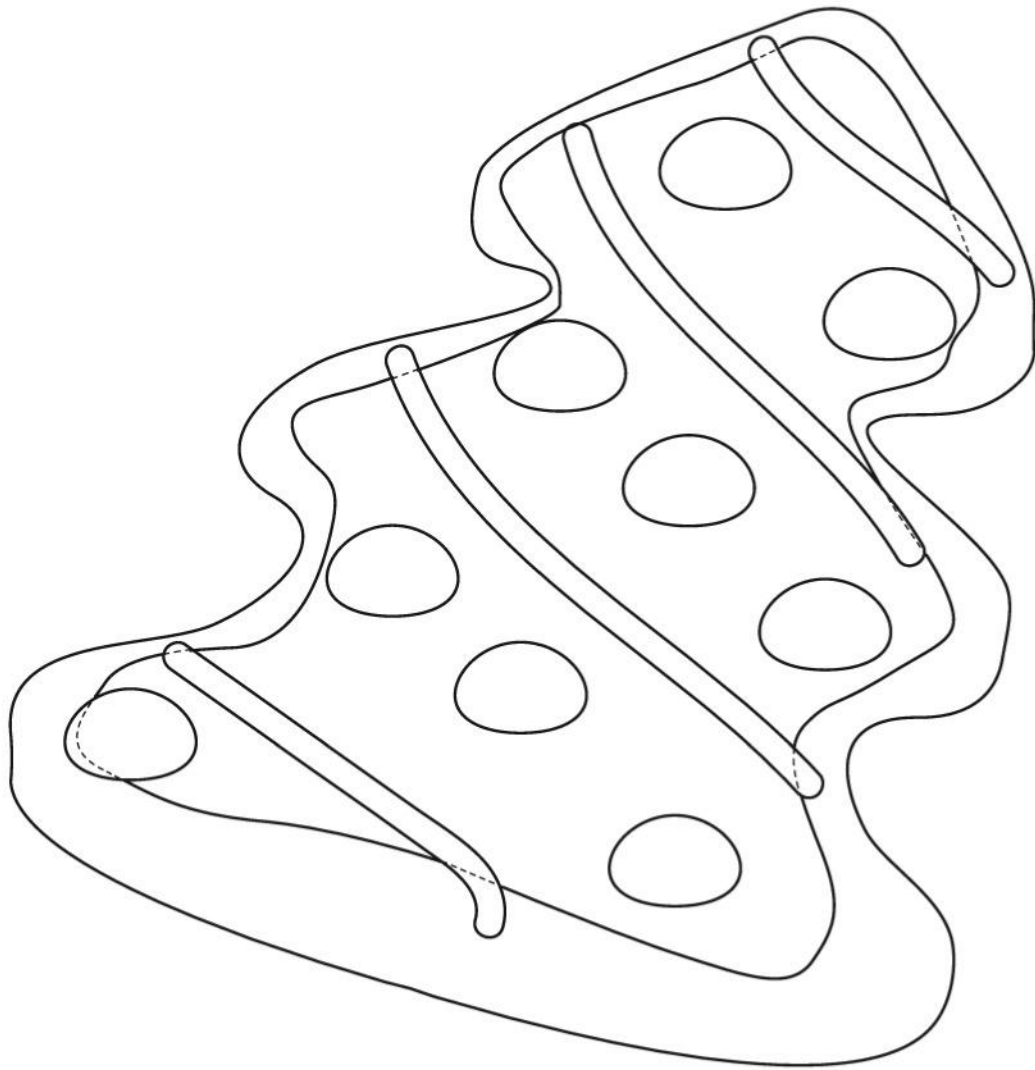

MERRY XMAS

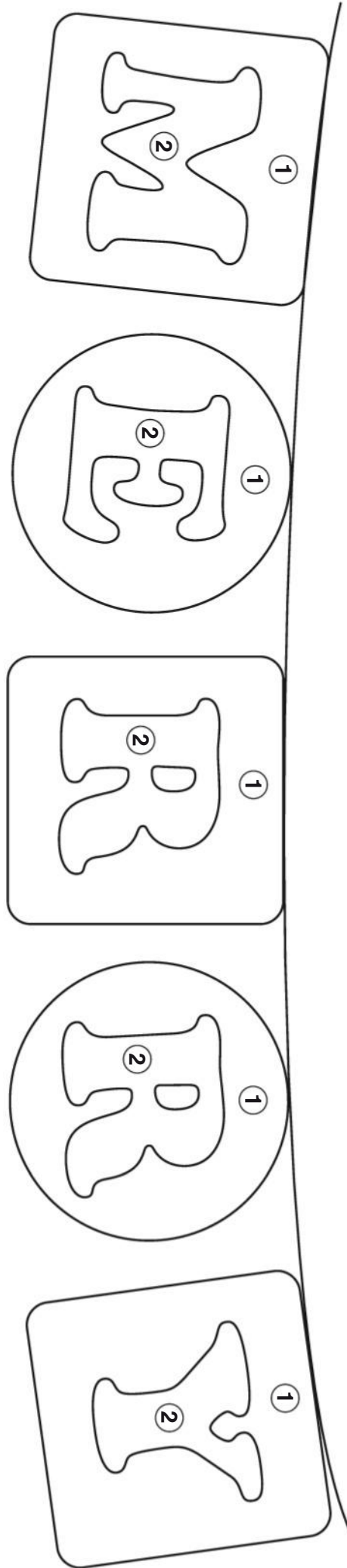
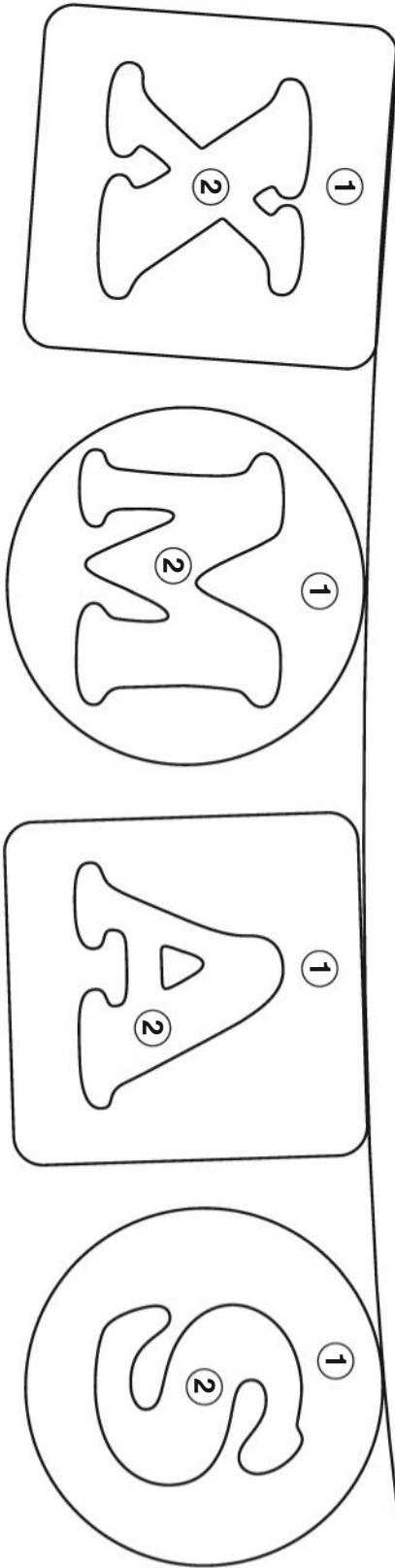

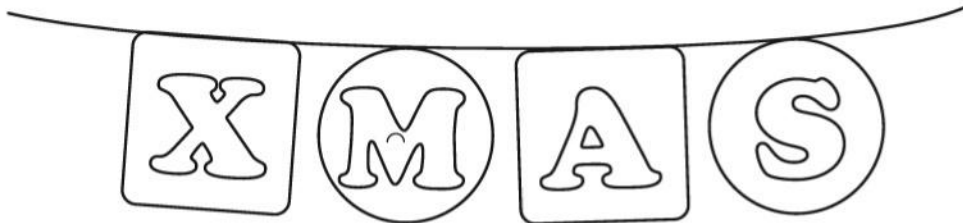
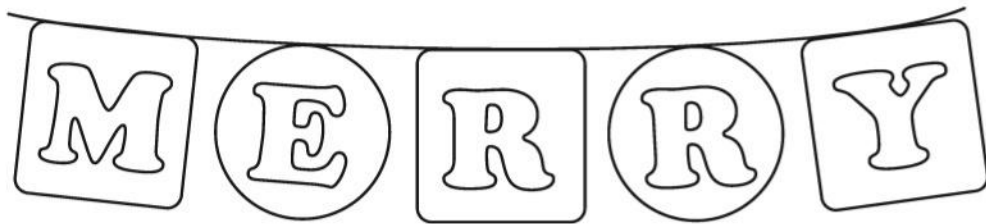
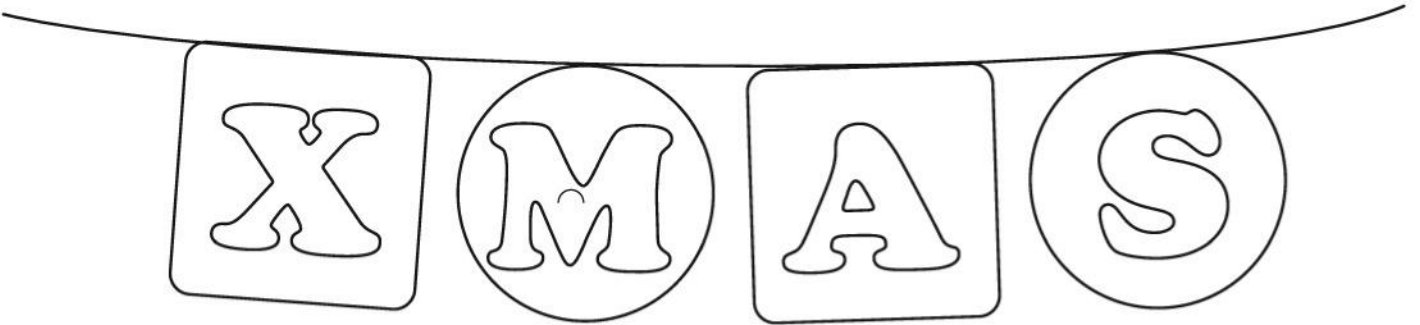
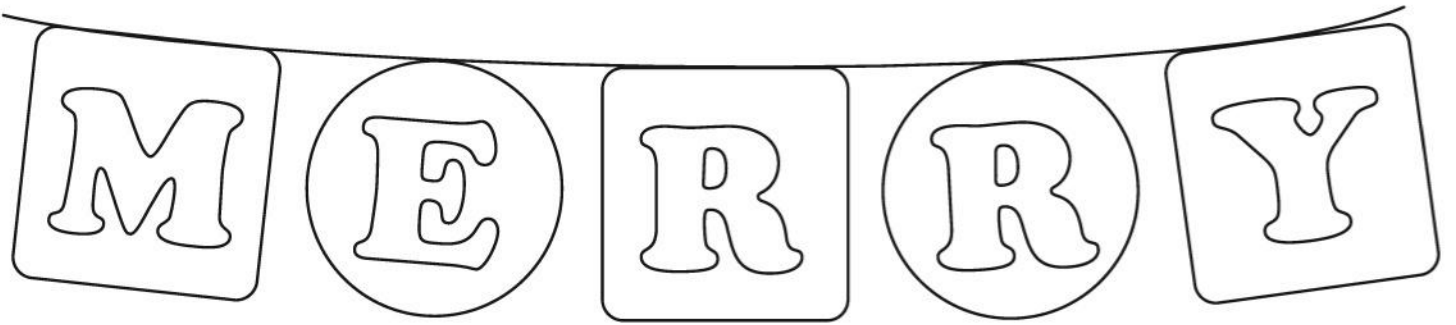

SNOWMAN

wise men

Christmas Tree

STOCKINGS

ELF

nutcracker

Mistletoe

PRESENTS

PIONSETTIA

father christmas

Candy Cane

ADVENT CALENDAR

MITTENS

gingerbread

Chocolates

WREATH

NEW

ON SALE NOW

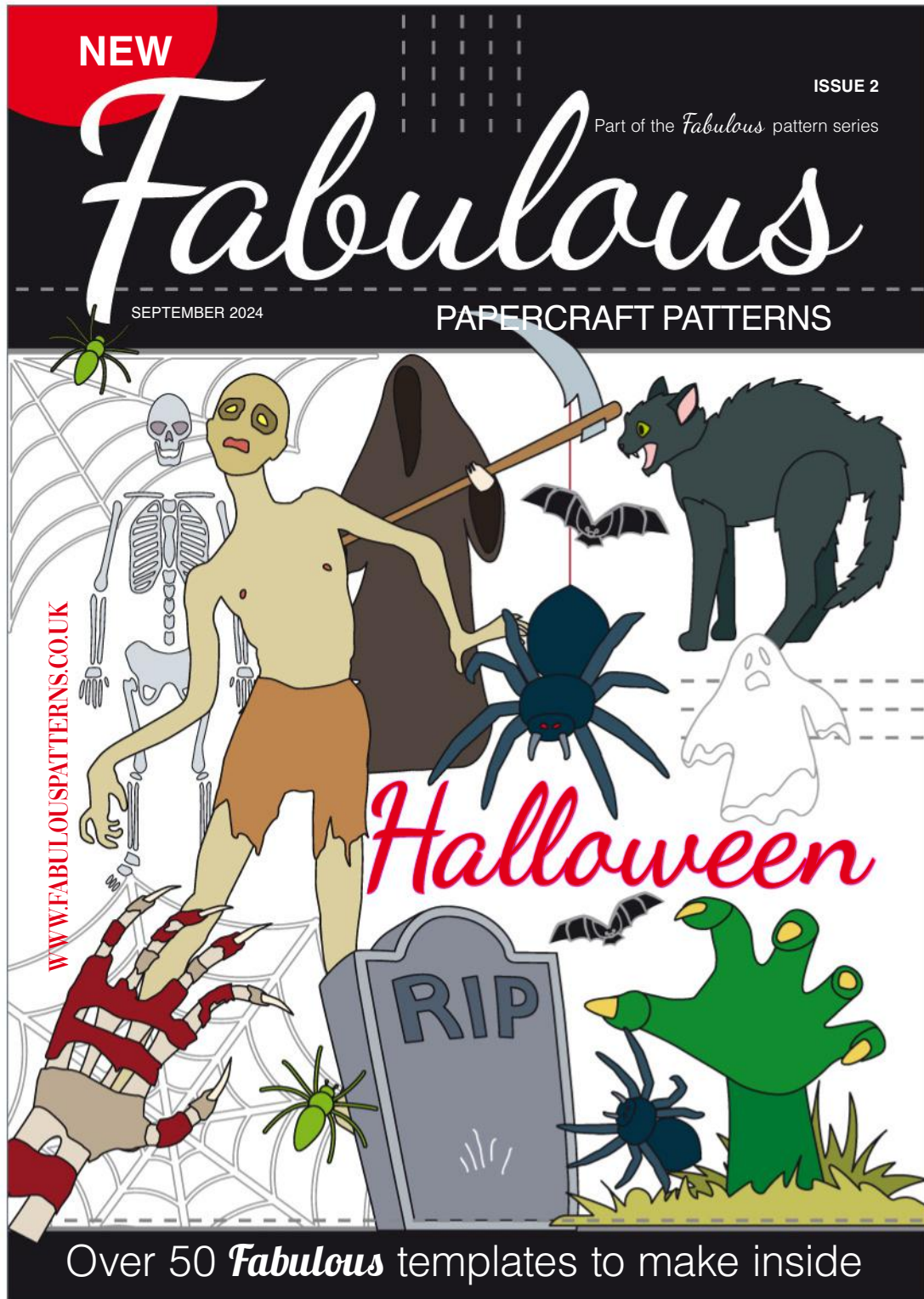

WWW.FABULOUSPATTERNS.CO.UK

WWW.FABULOUSPATTERNS.CO.UK

THEMED PATTERNS – ALL SKILL LEVELS – EVERY MONTH

Part of the *Fabulous* pattern series

NEW

www.fabulouspatterns.co.uk

ON SALE NOW

FOR LOVERS OF
Embroidery, papercraft
and patchwork appliqué

Special Issue!

Celebrate all the iconic
characters in our
anniversary edition

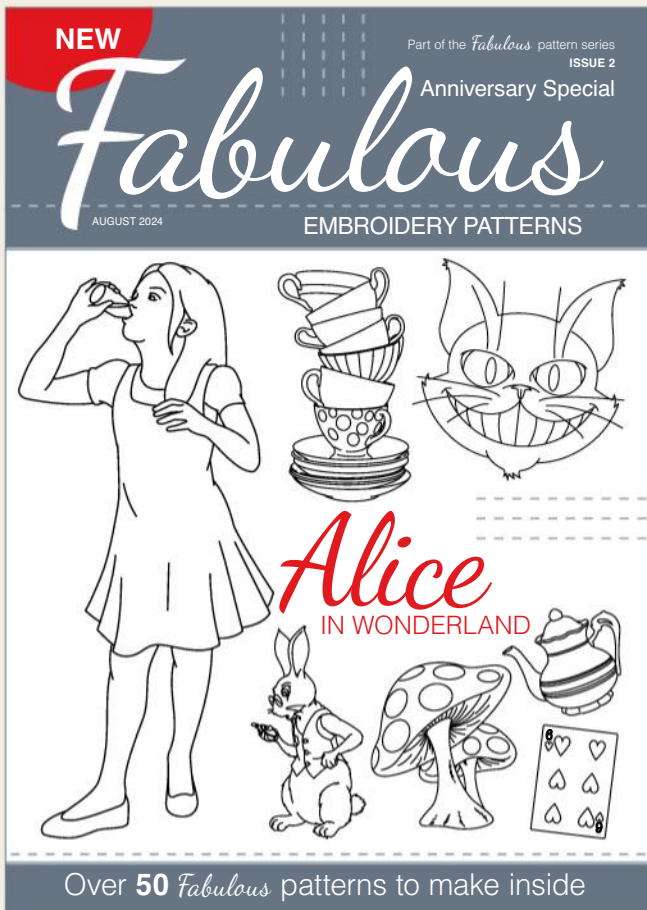
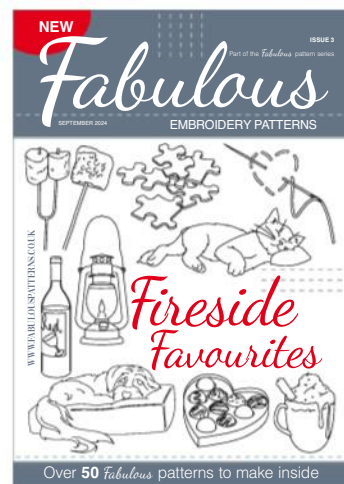
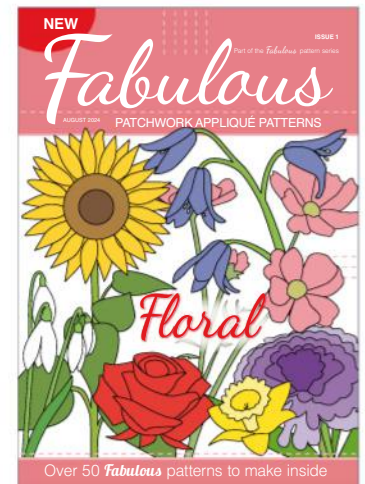
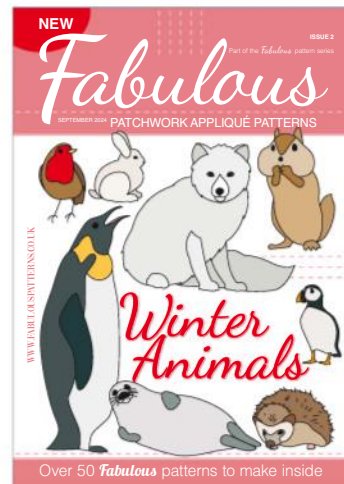
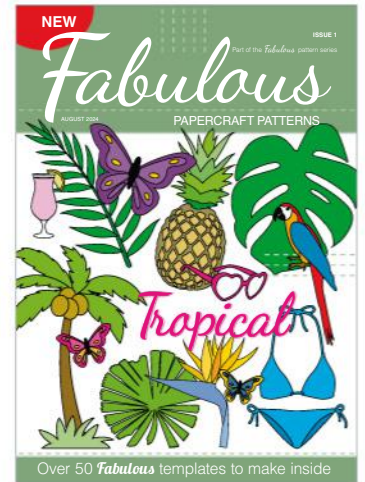
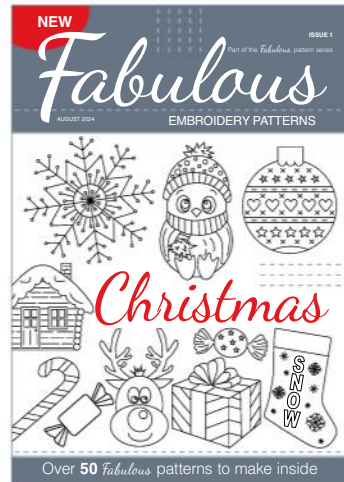

THEMED PATTERNS – ALL SKILL LEVELS – EVERY MONTH

Part of the *Fabulous* pattern series